

EN



Air-to-Water heat pump EVIPOWER PREMIUM INVERTER

OWNER'S MANUAL

MODELS:
CH-HP08UIMPRK-P
CH-HP12UIMPRK-P
CH-HP12UIMPRM-P
CH-HP23UIMPRK-P
CH-HP23UIMPRM-P

For proper operation, please read and keep this manual carefully.
Cooper&Hunter International Corporation, Oregon, USA
www.cooperandhunter.com

CONTENT

1	Preface	1
2	Safety Precaution	2
	(1) Mark notes	2
	(2) Icon Notes	2
	(3) Warning	3
	(4) Attention	4
3	Specification	5
	(1) Appearance and structure of the heat pump	5
	(2) The data of unit	5
	(3) Unit dimension	6
4	Installation	8
	(1) Application of heat pump	8
	(2) Choose a right heat pump unit	10
	(3) Installation place	10
	(4) Installation method	10
	(5) Water loop connection	11
	(6) Power supply connection	11
	(7) Location of the unit	11
	(8) Transit	12
	(9) Trial Running	12
5	Operation and Use	13
	(1) Main interface display and function	13
	(2) Parameter list and breakdown table	26
	(3) Interface diagram	29
6	Appendix	31
	(1) Appendix 1	31
	(2) Appendix 2	32

Preface

- In order to provide the customers with high quality, strong reliability and good versatility product, this heat pump is produced by strict design and manufacture standards.

This manual includes all the necessary information about installation, debugging, discharging and maintenance. Please read this manual carefully before you open or maintain the unit.

The manufacture of this product will not be held responsible if someone is injured or the unit is damaged, as a result of improper installation, debugging, unnecessary maintenance which is not in line with this manual.

The unit must be installed by qualified personnel.

- It is vital that the below instructions are adhered to at all times to keep the warranty.

—The unit can only be opened or repaired by qualified installer or an authorised dealer.

—Maintenance and operation must be carried out according to the recommended time and frequency, as stated in this manual.

—Use genuine standard spare parts only.

Failure to comply with these recommendations will invalidate the warranty.

- Inverter air source water heat pump is a kind of high efficiency, energy saving and environment friendly equipment, which is mainly used for house warming. It can work with any kind of indoor unit such fan coil, radiator, or floor heating pipe, by provide warm or hot water. One unit of monobloc heat pump can also work with several indoor units.

The air source water heat pump unit is designed to have heat recovery by using super heater which can provide hot water for sanitary purpose.

This series of heat pump unit owns following features:

- 1 Advanced controlling

The PC microcomputer based controller is available for the users to review or set the running parameters of the heat pump. Centralized controlling system can control several units by PC.

- 2 Nice appearance

The heat pump is designed with beautiful looking. The monobloc one has the water pump included which is very easy for installation.

- 3 Flexible installation

The unit has smart structure with compact body, just simple outdoor installation is needed.

- 4 Quiet running

High quality and efficient compressor, fan and water pump is used to ensure the low noise level with insulation.

- 5 Good heat exchange rate

The heat pump unit use special designed heat exchanger to enhance whole efficiency.



- 6 Large working range

This series of heat pump is designed to work under different working conditions as low as -15 degrees for heating.



Safety Precaution

To prevent the users and others from the harm of this unit, and avoid damage on the unit or other property, and use the heat pump properly, please read this manual carefully and understand the following information correctly.

Mark Notes



Mark	Meaning
 WARNING	A wrong operation may lead to death or heavy injury on people.
 ATTENTION	A wrong operation may lead to harm on people or loss of material.



Icon notes



Icon	Meaning
	Prohibition. What is prohibited will be nearby this icon
	Compulsory implement. The listed action need to be taken.
	ATTENTION (include WARNING) Please pay attention to what is indicated.

Safety Precaution

Warning

Installation	Meaning
 Professional installer is required.	The heat pump must be installed by qualified personals, to avoid improper installation which can lead to water leakage, electrical shock or fire.
 Earthing is required	Please make sure that the unit and power connection have good earthing, otherwise may cause electrical shock.

Operation	Meaning
 PROHIBITION	DO NOT put fingers or others into the fans and evaporator of the unit, otherwise harm may be occurred.
 Shut off the power	When there is something wrong or strange smell, the power supply need to be shut off to stop the unit. Continue to run may cause electrical short or fire.

Move and repair	Meaning
 Entrust	When the heat pump need to be moved or installed again, please entrust dealer or qualified person to carry it out. Improper installation will lead to water leakage, electrical shock, injury or fire.
 Entrust	It is prohibited to repair the unit by the user himself, otherwise electrical shock or fire may be occur.
 Prohibit	When the heat pump need to be repaired, please entrust dealer or qualified person to carry it out. Improper movement or repair on the unit will lead to water leakage, electrical shock, injury or fire.









Do not use means to accelerate the defrosting process or to clean, Other than those recommended by the manufacturer.

The appliance shall be stored in a room without continuously operating ignition sources (for example: open flames, an operating gas appliance or an operating electric heater.)

Safety Precaution

ATTENTION

Installation	Meaning
 Installation Place	The unit CANNOT be installed near the flammable gas. Once there is any leakage of the gas, fire can be occur.
 Fix the unit	Make sure that the basement of the heat pump is strong enough, to avoid any decline or fall down of the unit
 Need circuit breaker	Make sure that there is circuit breaker for the unit, lack of circuit breaker can lead to electrical shock or fire.

Operation	Meaning
 Check the installation basement	Please check the installation basement in a period (one month), to avoid any decline or damage on the basement, which may hurt people or damage the unit
 Switch off the power	Please switch off the power for clean or maintenance.
 Prohibition	It is prohibited to use copper or iron as fuse. The right fuse must be fixed by electrician for the heat pump.
 Prohibition	It is prohibited to spray the flammable gas to the heat pump, as it may cause fire.

Specification

1. Appearance and structure of the heat pump

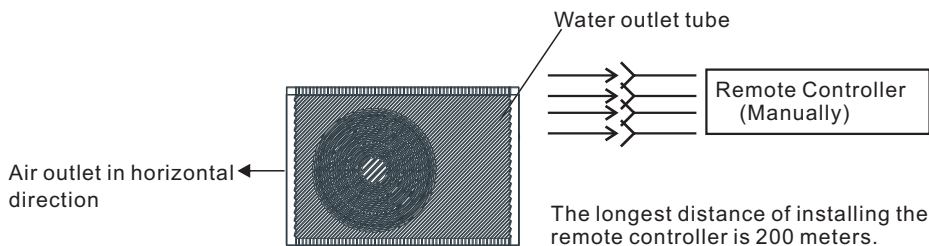

2. The data of unit

*** REFRIGERANT : R32

Model		CH-HP08UIMPRK-P	CH-HP12UIMPRK-P	CH-HP12UIMPRM-P	CH-HP23UIMPRK-P	CH-HP23UIMPRM-P
Heating Capacity	kW	2.30~8.20	3.80~12.50	3.80~12.50	7.00~23.00	7.00~23.00
Heating Power Input	kW	0.50~1.84	0.80~2.950	0.80~2.95	1.27~5.20	1.27~5.20
Cooling Capacity	kW	1.56~6.00	2.20~10.00	2.20~10.00	6.30~17.12	6.30~18.40
Cooling Power Input	kW	0.63~2.36	1.10~3.80	1.10~3.80	1.63~6.59	1.63~7.05
Hot Water Capacity	kW	3.00~9.50	4.15~16.00	4.15~16.00	10.21~29.88	10.21~29.88
Hot Water Power Input	KW	0.62~2.30	0.90~3.85	0.90~3.85	2.10~6.29	2.10~6.29
Max Power Input	KW	2.90	4.95	4.95	6.60	8.30
Max Current Input	A	13.0	21.4	8.0	30.0	15.0
Power Supply		220-240V~/50Hz	220-240V~/50Hz	380-415V~/50Hz	220-240V~/50Hz	380-415V~/50Hz
Compressor Quantity		1	1	1	1	1
Compressor Model		Rotary	Rotary	Rotary	Rotary	Rotary
Fan Quantity		1	1	1	2	2
Fan Power Input	W	150	170	170	75	75
Fan Rotate Speed	RPM	600	600	600	600	600
Water Pump Input	W	60	60	60	160	160
Noise	dB(A)	37~48	39~52	39~52	42~54	42~54
Water Connection	inch	1	1	1	1	1
Water Flow Volume	m3/h	1.0	1.7	1.7	2.9	2.9
Water Head	m	5.0	4.5	4.5	6.9	6.9
Unit Net Dimensions (L/W/H)	mm	See drawings of the heat pump				
Unit Shipping Dimensions (L/W/H)	mm	see data on the package				
Net Weight	kg	see data on the nameplate				
Shipping Weight	kg	see data on the package				

Cooling working condition:(DB/WB)35°C/24°C, (Outlet/Inlet) 7°C/12°C.

Heating working condition: (DB/WB) 7°C/6°C. (Outlet/Inlet) 35°C/30°C.

Hot Water working condition:(DB/WB): 20°C/15°C,water tank temperature circulation form15°C to 55°C 。

BS EN 14511-1-2013 Air conditioner, whole liquid cooling machine, electric compressor.

Part2: Test condition ; Part3:Test method ; Part4:related requirements.

Specification

3. Unit dimension

Models:CH-HP08UIMPRK-P

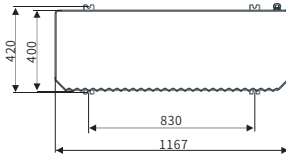
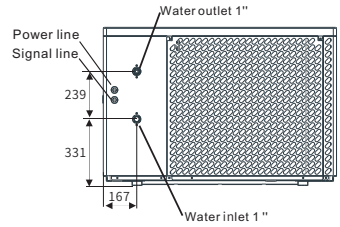
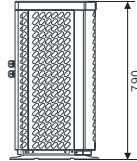
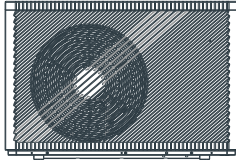

Models:CH-HP12UIMPRK-P
CH-HP12UIMPRM-P

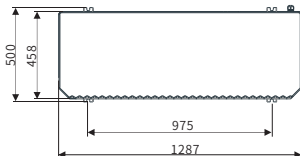
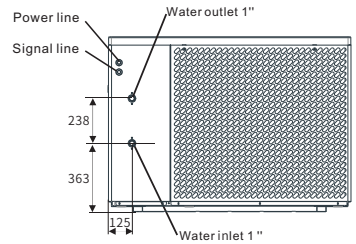
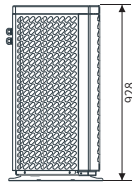
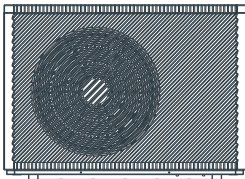

Specification

3. Unit dimension

Models: CH-HP23UIMPRK-P
CH-HP23UIMPRM-P

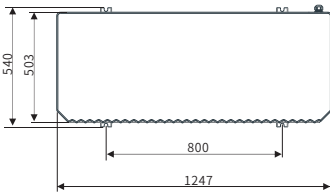
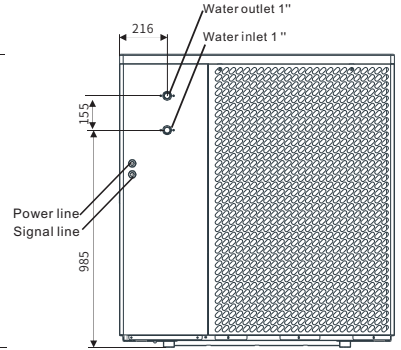
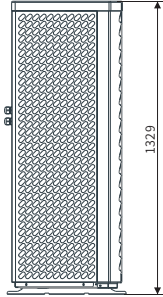
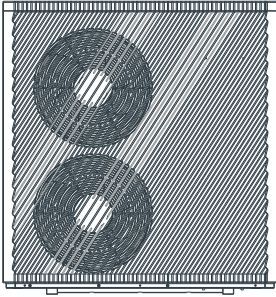

Installation

Unit features

1. Plate heat exchanger

Use the SWEP efficient heat exchanger with small size and high efficiency.

2.Environmentally friendly refrigerant

Use the new generation of environmentally friendly refrigerant R32, which is harmless to the ozone sphere.

3. Heating in frigid environment.

Optimized designed unit can achieve the heating function normally even when the ambient temperature is -25°C .

1 Application of heat pump

1.1 House Heating/Cooling + Domestic Hot Water

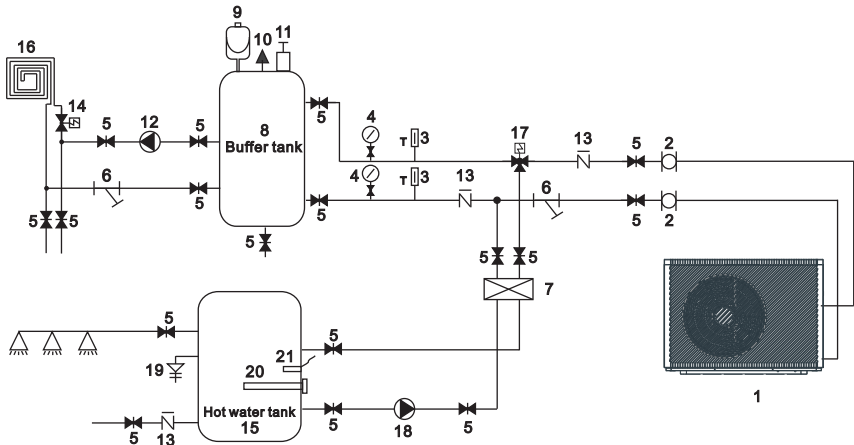

1	Heat pump	10	Relief valve	19	PT valve
2	Flexible pipe	11	Air vent valve	20	Electrical heater
3	Thermometer	12	Water pump for floor heating	21	Hot water sensor
4	Manometer	13	Check valve		
5	Shut-off valve	14	Floor heating valve		
6	Y type water filter	15	Hot water tank		
7	Plate heat exchanger	16	Floor heating pipe/fan coil unit		
8	Buffer tank	17	Hot water valve		
9	Expansion tank	18	Hot water pump		

Remark:Item 17, 18, 20, 21 can be connected with heat pump.

Installation

1.2 House Heating/Cooling (includes Buffer tank)

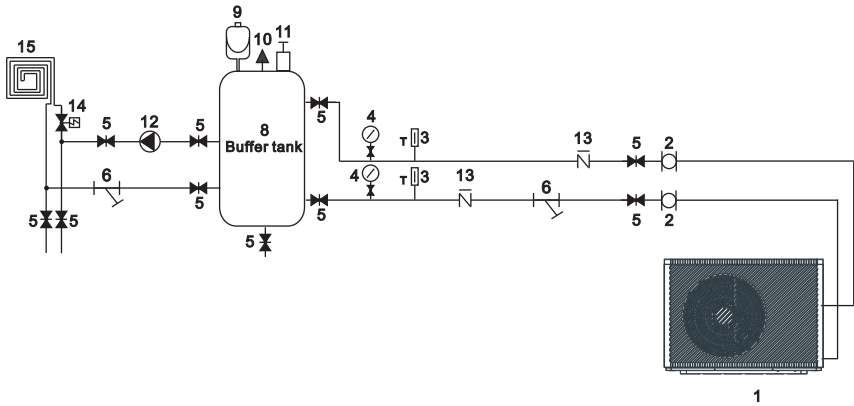

1	Heat pump	7	Plate heat exchanger	13	Check valve
2	Flexible pipe	8	Buffer tank	14	Floor heating valve
3	Thermometer	9	Expansion tank	15	Floor heating pipe/fan coil unit
4	Manometer	10	Relief valve		
5	Shut-off valve	11	Air vent valve		
6	Y type water filter	12	Water pump for floor heating		

1.3 House Heating/Cooling (Not includes Buffer tank)

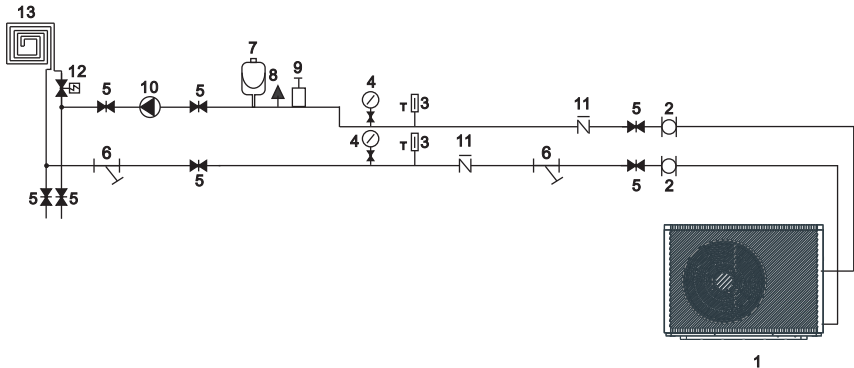

1	Heat pump	7	Expansion tank	13	Floor heating pipe/fan coil unit
2	Flexible pipe	8	Relief valve		
3	Thermometer	9	Air vent valve		
4	Manometer	10	Water pump for floor heating		
5	Shut-off valve	11	Check valve		
6	Y type water filter	12	Floor heating valve		

Installation

2 Choose a right heat pump unit

- 2.1 Based on the local climate condition, construction features and insulation level, calculate the required cooling(heating) capacity per square meter.
- 2.2 Conclude the total capacity which will be needed by the construction.
- 2.3 According to the total capacity needed, choose the right model by consulting the heat pump features as below:
Heat pump features
 - Cooling only unit: chilled water outlet temp. at 5-15°C, maximum ambient temp. at 43°C.
 - Heating and Cooling unit: for cooling chilled water outlet temp. at 5-15°C, maximum ambient temp. at 43°C. For heating, warm water inlet temp. at 40-50°C, minimum ambient temp. at -25°C.
 - Unit application
Inverter air source water heat pump is used for house, office, hotel, and so forth, which need heating or cooling separately, with each area need to be controlled.

3 Installation place

- The unit can be installed on any place outdoor which can carry heavy machine such as terrace, housetop, ground and so on.
- The location must have good ventilation.
- The place is free from heat radiation and other fire flame.
- A pall is needed in winter to protect the heat pump from snow.
- There must be not obstacles near the air inlet and outlet of the heat pump.
- A place which is free from strong air blowing.
- There must be water channel around the heat pump to drain the condensing water .
- There must be enough space around the unit for maintenance.

4 Installation method

The heat pump can be installed onto the concrete basement by expansion screws, or onto a steel frame with rubber feet which can be placed on the ground or housetop. Make sure that the unit is placed horizontally.

Installation

5 Water loop connection

Please pay attention to below matters when the water pipe is connected:

- Try to reduce the resistance to the water from the piping.
- The piping must be clear and free from dirty and blocks. Water leakage test must be carried out to ensure there is no water leaking. And then the insulation can be made.
- Attention that the pipe must be tested by pressure separately. DO NOT test it together with the heat pump.
- There must be expansion tank on the top point of the water loop, and the water level in the tank must be at least 0.5 meter higher than the top point of the water loop.
- The flow switch is installed inside of the heat pump, check to ensure that the wiring and action of the switch is normal and controlled by the controller.
- Try to avoid air stayed inside of the water pipe, and there must be air vent on the top point of the water loop.
- There must be thermometer and pressure meter at the water inlet and outlet, for easy inspection during running.

6 Power supply connection

- Open the front panel, and open the power supply access.
- The power supply must go through the wire access and be connected to the power supply terminals in the controlling box. Then connect the 3-signal wire plugs of the wire controller and main controller.
- If the outside water pump is needed, please insert the power supply wire into the wire access also and connect to the water pump terminals.
- If an additional auxiliary heater is need to be controlled by the heat pump controller, the relay (or power) of the aux-heater must be connected to the relevant output of the controller.

7 Location of the unit

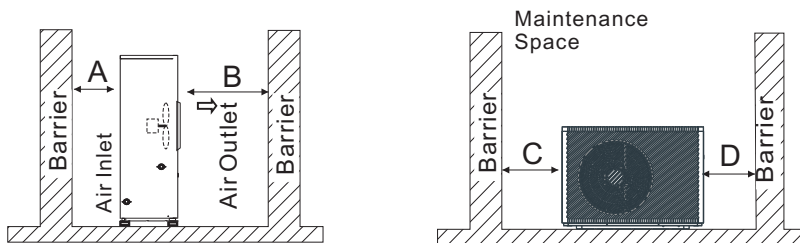

The picture shows the location of horizontal air outlet unit.



Attention

Requirements

A>500mm ; B>1500mm ;

C>1000mm ; D>500mm

The minimum ventilation distance in diagram 1.

Installation

8 Transit

When the unit need to be hung up during installation, a 8 meters cable is needed, and there must be soft material between the cable and the unit to prevent damage to the heat pump cabinet. (See picture 1)

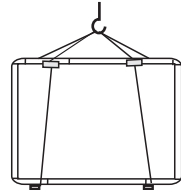

Picture 1



WARNING

DO NOT touch the heat exchanger of the heat pump with fingers or other objects !

9 Trial Running

Inspection before trial running

- Check the indoor unit, and make sure that the pipe connection is right and the relevant valves are open .
- Check the water loop, to ensure that the water inside of the expansion tank is enough, the water supply is good, the water loop is full of water and without any air. Also make sure there is good insulation for the water pipe.
- Check the electrical wiring. Make sure that the power voltage is normal, the screws are fastened, the wiring is made in line with the diagram, and the earthing is connected.
- Check the heat pump unit including all of the screws and parts of the heat pump to see if they are in good order. When power on, review the indicator on the controller to see if there is any failure indication. The gas gauge can be connected to the check valve to see the high pressure(or low pressure) of the system during trial running.

Trial running

- Start the heat pump by press "🔊" key on the controller. Check whether the water pump is running, if it runs normally there will be 0.2 MPa on the water pressure meter.
- When the water pump runs for 1 minutes, the compressor will start. Hear whether there is strange sound from the compressor. If abnormal sound occurs please stop the unit and check the compressor. If the compressor runs well please look for the pressure meter of the refrigerant.
- Then check whether the power input and running current is in line with the manual. If not please stop and check.
- Adjust the valves on the water loop, to make sure that the hot(cool) water supply to each door is good and meet the requirement of heating(or cooling).
- Review whether the outlet water temperature is stable.
- The parameters of the controller are set by the factory, it is not allowed to change then by user himself.

Operation and Use

1. Main interface display and function

(1) Power on interface



(2) Starting up interface

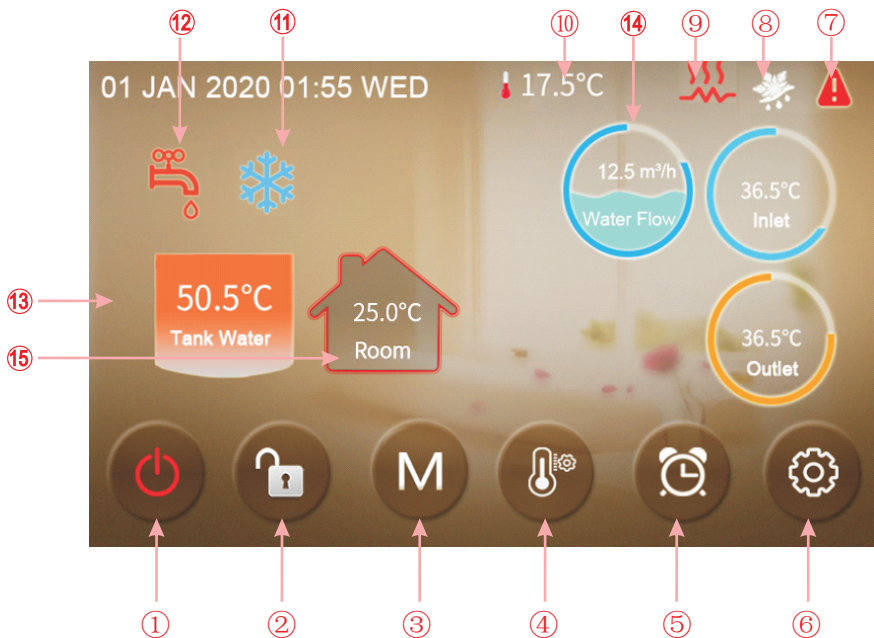

Key function

Key number	Key name	Key function
①	On and off	Click this key to switch ON or OFF Red represents ON, while grey represents OFF
②	Lock screen	Click this key to lock the screen. White represents not enabled, while green represents enabled
③	Mode key	Hot water mode, heating mode, cooling mode, hot water+heating mode or hot water+cooling mode can be selected by pressing this key.
④	Temperature setting	Click this key to set the target temperature
⑤	Timer setting	Click this key to set the timer. White represents not enabled, while green represents enabled
⑥	Setup key	Click this key to check the unit status, time, factory parameter, temperature curve, timer setting and Mute setting

Note:

- ⑦ is fault icon, This icon will flash when there is an error shown up, then the display will enter Failure record interface after tapping this icon;
- ⑧ is defrosting icon, the machine is in defrosting mode when this icon is shown;
- ⑨ is electric heater icon, the machine is in electric heater mode when this icon is shown;
- ⑩ is ambient temperature icon, show the current ambient temperature;
- ⑪ is heating mode icon, the machine is in cooling mode when this icon is shown;
- ⑫ is hot water mode icon, the machine is in hot water mode when this icon is shown;
- ⑬ is tank water temperature icon, the machine is in hot water mode when this icon is shown; otherwise, this icon is not shown;
- ⑭ is water flow icon, showing the current water flow (note: When H31=0, the icon is not displayed)
- ⑮ is room temperature icon, show the current room temperature;

Operation and Use

1.1 On and off

As the main interface shows

- (1) .In shutting down interface (on/off key is in gray status), press on/off key can start up the machine.

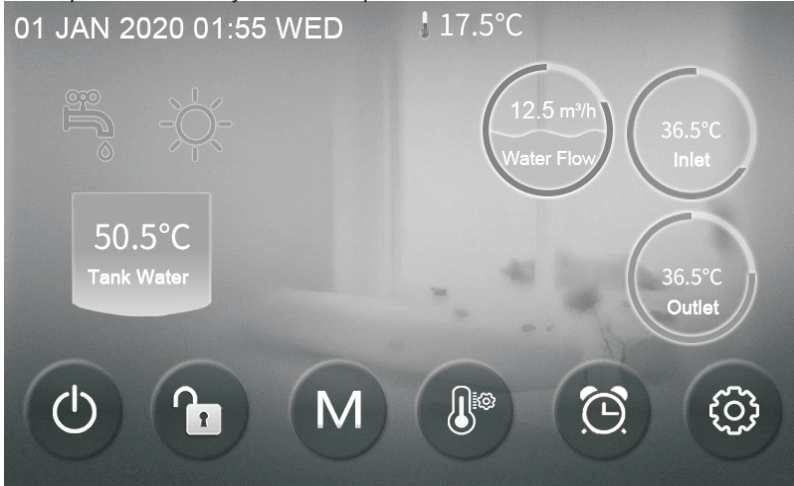

- (2) Note: In starting up interface (on/off key is in red status), press on/off key can shut down the machine.

1.2 Mode switch

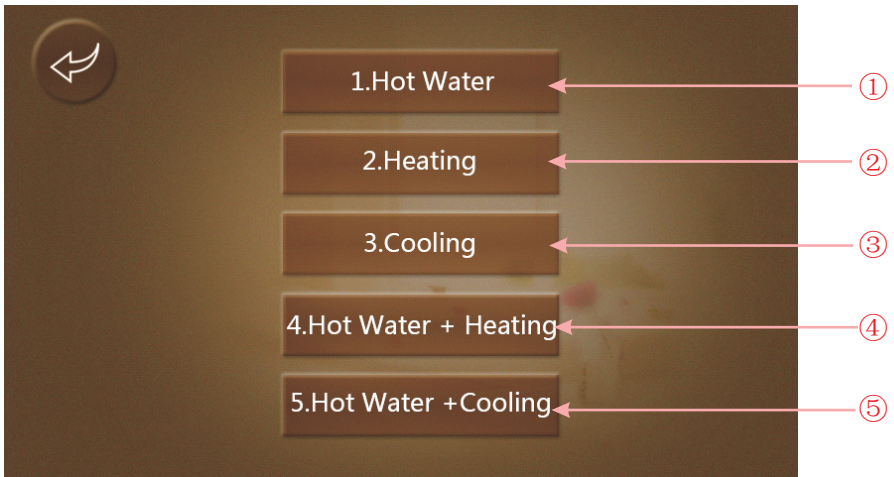

Operation and Use

In the main interface, there are five modes can be selected after tapping the mode key.

- (1) tapping hot water mode icon ①, then the display will change to this mode interface;
- (2) tapping heating mode icon ②, then the display will enter this mode interface;
- (3) tapping cooling mode icon ③, then the display will switch to this mode interface;
- (4) tapping hot water+heating mode icon ④, then the display will go into hot water+heating mode interface;
- (5) tapping hot water+cooling mode icon ⑤, then the display will come to hot water+cooling mode interface;

Note: If what you have purchased is a heating-only model (without cooling function), the "cooling" will not be shown on the interface.

1.3 Setting of target temperature



Take hot water + cooling mode for example:

Tapping ①, the wire controller back to main interface;

Tapping ②, the target temp of hot water can be set by pop-up keyboard;

Tapping ③, the target temp of cooling mode can be set by pop-up keyboard.

Operation and Use

1.4 When the target temp is being set, pop-up keyboard is shown as following:

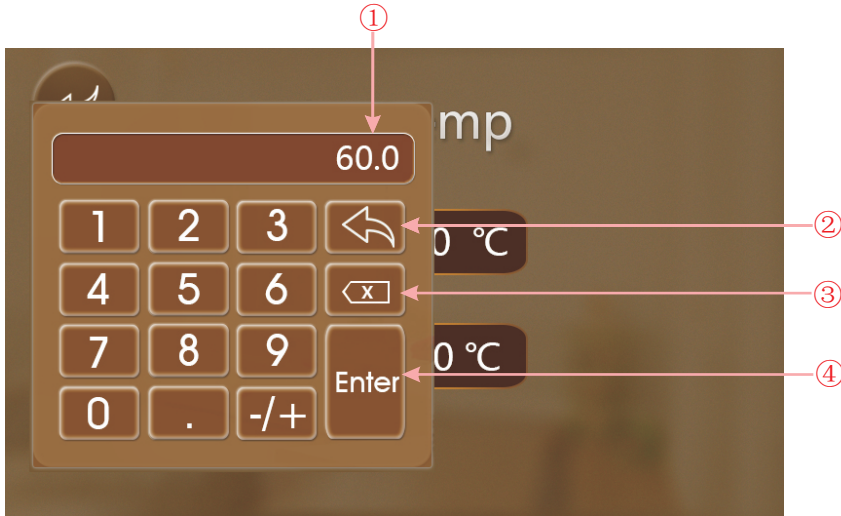

Key number	Key name	Key function
②	Return key	Tapping this key can back to the main interface.
③	Delete key	Tapping this key to undo the last action.
④	Enter key	Tapping this key can save you action and back to the main interface.

Note: ① means the new target temp under current setting

1.5 Unlock screen

Click the lock screen key again while the screen has been locked, pop-up keyboard is shown as following:



Note: Input the password of 22 or 022, click the enter key and the screen will be unlocked.

1.6 Timer setting

Click the timer setting key to enter the timer setting and the interface display is as follows:

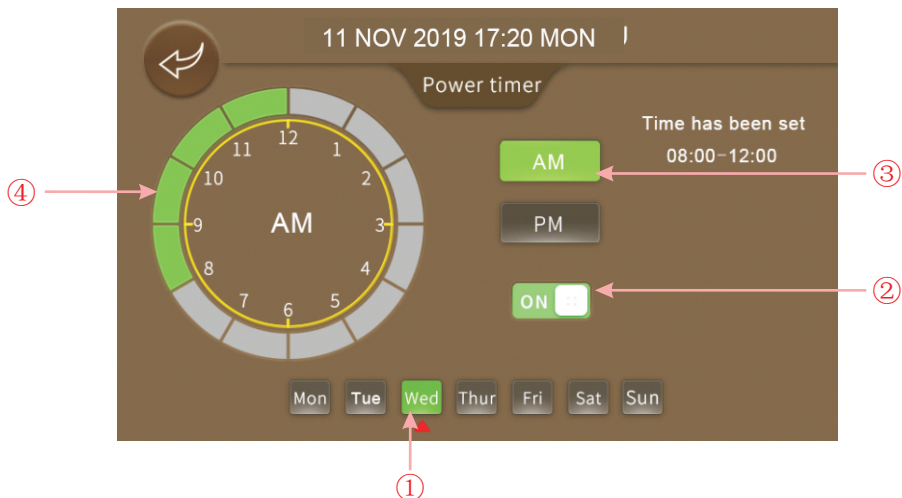

Note: Click ① to set the day of the week, click ② to activate the Timing switch function, then click ③ to select the morning or afternoon mode, and finally click ④ to select the time period to turn on the Timing switch.

1.7 Setup

Click the setup key to enter the setup and the interface display is shown as follows:

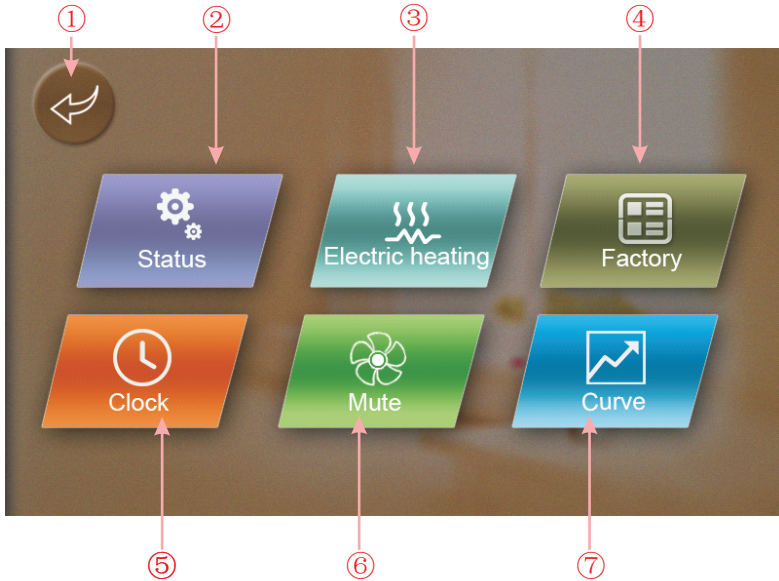

Key number	Key name	Key function
①	Return key	Click this key to return to the main interface.
②	Operating mode	Click this key to view the current operating parameters of the unit.
③	Electric heating	Click this key to turn on the unit Electric heating.
④	Factory parameter	Click the key and enter the password to enter the factory parameter settings and status parameters interface.
⑤	System time setting	Click this key to set the system time.
⑥	Mute setting	Click this key to set the unit mute function mode.
⑦	Curve key	Click this key to view the temperature curve.

Note:

If the unit has ②, ⑥ or both functions, the corresponding icon will be displayed on the setting interface.

Operation and Use

In the setup interface:

(1) Tapping operating mode button ②, then the interface display is shown as follows:

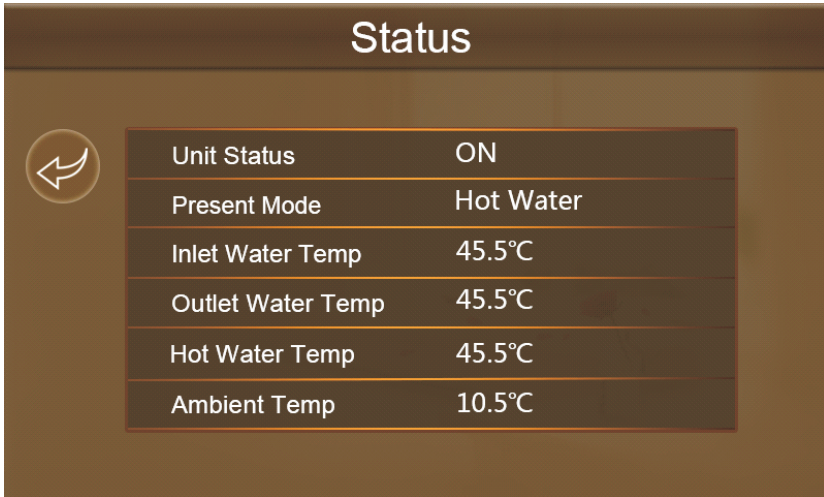

The screenshot shows a 'Status' screen with a circular arrow icon on the left. The screen displays the following information:

Status	
Unit Status	ON
Present Mode	Hot Water
Inlet Water Temp	45.5°C
Outlet Water Temp	45.5°C
Hot Water Temp	45.5°C
Ambient Temp	10.5°C

Operation and Use

(2) Tapping system time setting button ⑤, then the interface display is shown as follows:



Key number	Key name	Key function
①	Return key	Click this key to return to the setup interface.
②	Up key	Click this key to increase the value.
③	Down key	Click this key to decrease the value.
④	Cannel key	Click this key to cancel the current settings and return to the settings page.
⑤	Enter key	Click this key to save the current settings .

Note:

- ①: Click the up and down key to set the month;
- ②: Click the up and down key to set the day;
- ③: Click the up and down key to set the year;
- ④: Click the up and down key to set the hour;
- ⑤: Click the up and down key to set the minute;
- ⑥: Click the key to cancel the setting;
- ⑦: Click the key to determine the setting, and the system will be automatically calibrated if it is incorrect.

Operation and Use

(3) Tapping Electric heating button③, then the interface display is shown as follows:

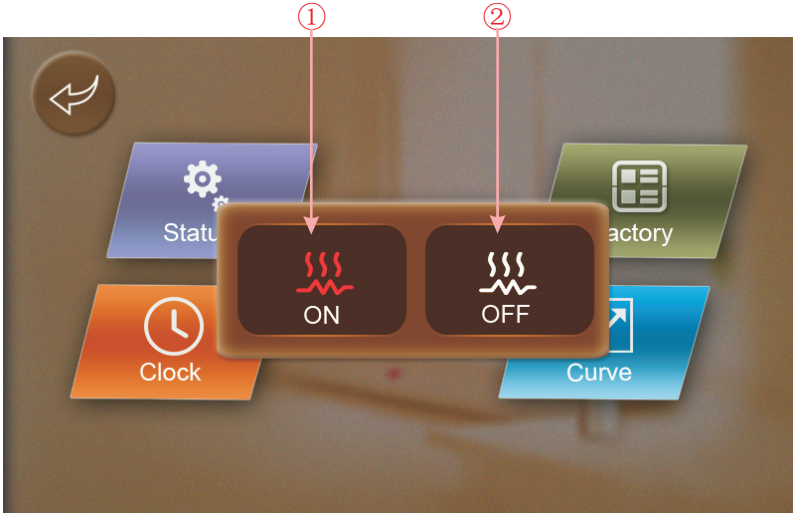

Note:

When the unit starts the electric heating , the icon is displayed as ①;

When the unit closes the electric heating , the icon is displayed as ②;

While the unit is in cooling mode , clicking the icon ①, the electric heating will not be turned on;

While the unit is in hot water+cooling mode , if the hot water side is running, the electric heating will be operated and shown; if the cooling side is running, clicking the icon ①, the electric heating will not be turned on.

(4) Tapping Mute setting button⑥, then the interface display is shown as follows:

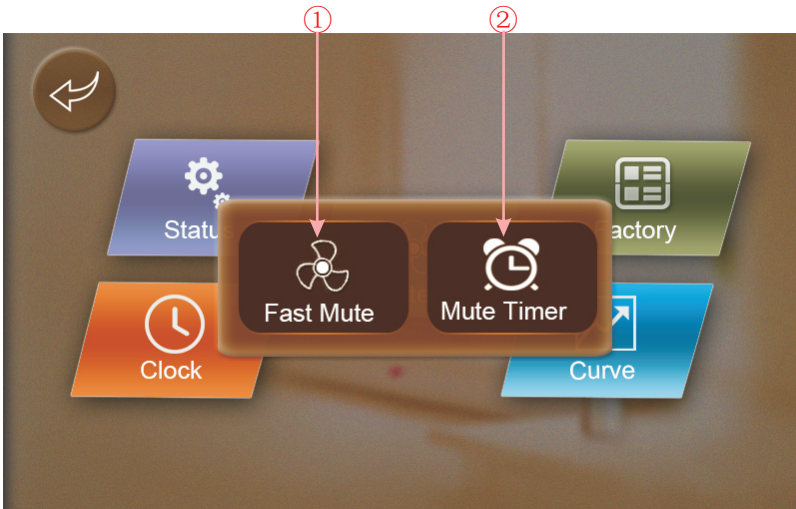

Operation and Use

Note:

When the unit is enabled to activate the mute function, the icon ① is displayed as ;

When the unit is enabled to activate the powerful function, the icon ① is displayed as .

(4.1) Tapping Mute Timer button ②, then the interface display is shown as follows:

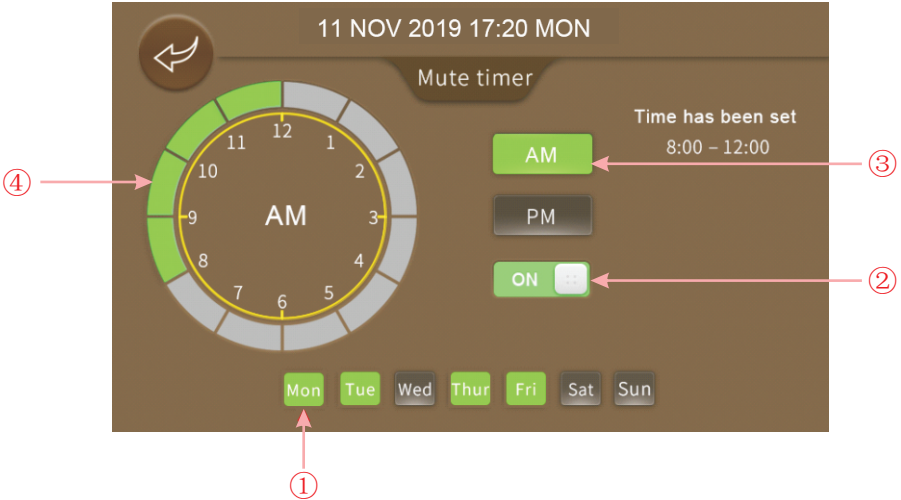

Note: Click ① to set the day of the week, click ② to activate the mute mode, then click ③ to select the morning or afternoon mode, and finally click ④ to select the time period to turn on the silent mode.

(5) Tapping Curve button ⑦, then the interface display is shown as follows:

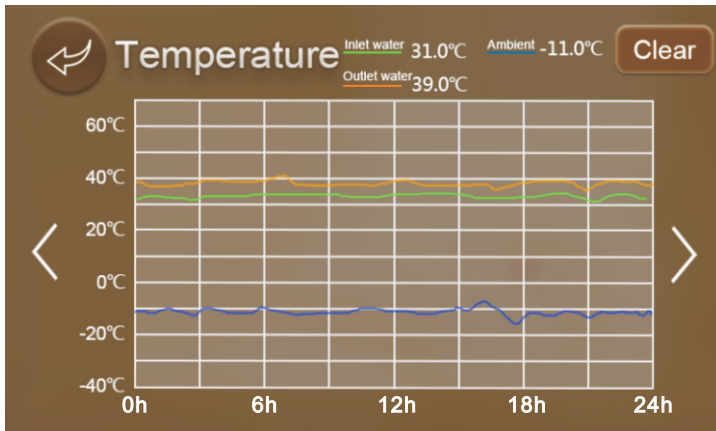

Operation and Use

- 1) This curve function records the water inlet temperature and water outlet temperature;
- 2) Temperature data is collected every five minutes and the 12 sets of temperature data are saved every hour. Timekeeping is made from the latest data saving, if the power is disrupted when the time is less than 1 hour (12 sets), the data during such period will not be saved.
- 3) Only curve for power-on status is recorded, and that for power-off will not be saved;
- 4) The value of the abscissa indicates the time from the point on the curve to the current time point. The leftmost point on the first page (0 on the abscissa) is the latest temperature record;
- 5) Temperature curve record is provided with power-down memory function.

1.7 Fault interface

Click the fault icon on the main interface and the interface display is as follows:

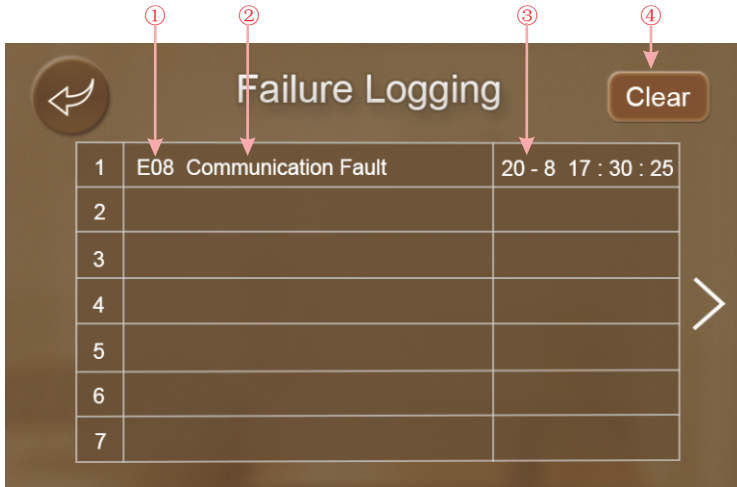

Note:

- ①: Fault code
- ②: Fault name
- ③: Occurrence time of the fault, Day and month hour : minute : second
If the current temperature is °F, Month and day hour : minute : second
- ④: Click this key to clear all fault records

1.8 Color Display Calibration

Keep click quickly at the blank area on any interface till you hear a long beep. Then you will enter the calibration interface. Click "+" to start calibration.

When you hear the beep again, you will finish calibration and exit

2.Parameter list and breakdown table

2.1 Electronic control fault table

Can be judged according to the remote controller failure code and troubleshooting

Protect/fault	Fault display	Reason	Elimination methods
Standby	Non		
Normal boot	Non		
Inlet Temp Sensor Fault	P01	The temp. Sensor is broken or short circuit	Check or change the temp. Sensor
Outlet Temp Sensor Fault	P02	The temp. Sensor is broken or short circuit	Check or change the temp. Sensor
Water Tank Temp Sensor	P03	The temp. Sensor is broken or short circuit	Check or change the temp. Sensor
AT Sensor Fault	P04	The temp. Sensor is broken or short circuit	Check or change the temp. Sensor
Syst1:Coil temp Sensor	P153	The temp. Sensor is broken or short circuit	Check or change the temp. Sensor
Syst1:Suction temp Sensor	P17	The temp. Sensor is broken or short circuit	Check or change the temp. Sensor
Syst1:Exhaust temp Sensor	P181	The temp. Sensor is broken or short circuit	Check or change the temp. Sensor
Syst1: Exhaust Overtemp	P182	The compressor is overload	Check whether the system of the compressor running normally
Syst1: Pressure Sensor Fault	PP11	The pressure Sensor is broken or short circuit	Check or change the pressure Sensor or pressure
Syst2: Pressure Sensor Fault	PP21	The pressure Sensor is broken or short circuit	Check or change the pressure Sensor or pressure
Syst1:Inlet Sensor(EVI)	P101	The temp. Sensor is broken or short circuit	Check or change the temp. Sensor
Syst1:Outlet Sensor(EVI)	P102	The temp. Sensor is broken or short circuit	Check or change the temp. Sensor
Low AT Protection	TP	The ambient temp. is low	Check the ambient temp value
Flow Switch Protection	E032	No water/little water in water system	Check the pipe water flow and water pump
Aux Superheat Protection	E04	The electric-heater protection switch is broken	Check to see whether the electric heater has been running under the temperature over 150 for a long time
Room Temp Sensor Fault	P42	The temp. Sensor is broken or short circuit	Check or change the temp. Sensor
Communication Fault	E08	Communication failure between wire controller and mainboard	Check the wire connection between remote wire controller and main board
Communication Fault (speed control module1)	E081	Speed control module and main board communication fail	Check the communication connection
Syst1:HP Protection	E11	The high-pressure switch is broken	Check the pressure switch and cold circuit
Syst1:LP Protection	E12	The low-pressure switch is broken	Check the pressure switch and cold circuit
Syst1:Antifreeze	E171	Use side water system temp. is low	1.Check the water temp. or change the temp. Sensor 2.Check the pipe water flow and whether water system is jammed or not
Prim Anti-freezing Prot	E19	The ambient temp. is low	Check the ambient temp value
Secondary Anti-freezing Prot	E29	The ambient temp. is low	Check the ambient temp value
Fan Motor 1 Fault	F031	1. Motor is in locked-rotor state 2.The wire connection between DC-fan motor module and fan motor is in bad contact	1.Change a new fan motor 2.Check the wire connection and make sure they are in good contact
Fan Motor 2 Fault	F032	1. Motor is in locked-rotor state 2.The wire connection between DC-fan motor module and fan motor is in bad contact	1.Change a new fan motor 2.Check the wire connection and make sure they are in good contact

Operation and Use

Protect/fault	Fault display	Reason	Elimination methods
Syst1:Antifreeze Sensor1	P191	The temp. Sensor is broken or short circuit	Check or change the temp. Sensor
Syst1:Antifreeze Sensor2	P193	The temp. Sensor is broken or short circuit	Check or change the temp. Sensor
Syst2:Antifreeze Sensor1	P291	The temp. Sensor is broken or short circuit	Check or change the temp. Sensor
Syst2:Antifreeze Sensor2	P293	The temp. Sensor is broken or short circuit	Check or change the temp. Sensor
Syst2:Coil temp Sensor	P25	The temp. Sensor is broken or short circuit	Check or change the temp. Sensor
Syst2:Suction temp Sensor	P27	The temp. Sensor is broken or short circuit	Check or change the temp. Sensor
Syst2:Exhaust temp Sensor	P281	The temp. Sensor is broken or short circuit	Check or change the temp. Sensor
Syst2: Exhaust Overtemp	P282	The compressor is overload	Check whether the system of the compressor running normally
Syst1:Comp Overcurrent	E101	The compressor is overload	Check whether the system of the compressor running normally
Syst2:Comp Overcurrent	E201	The compressor is overload	Check whether the system of the compressor running normally
Syst2:Inlet Sensor(EVI)	P201	The temp. Sensor is broken or short circuit	Check or change the temp. Sensor
Syst2:Outlet Sensor(EVI)	P202	The temp. Sensor is broken or short circuit	Check or change the temp. Sensor
Outlet Water Overtemp.	E065	No water/little water in water system	Check the pipe water flow and water pump
Outlet Water Lowtemp.	E071	No water/little water in water system	Check the pipe water flow and water pump
Driver Board Self Test	E003	The Fan Motor Fault	Check the fan and drive board
The Wire Controller Does Not Match The Mainboard	E084	The wire controller software is not match the mainboard software	Check the wire control software number and the mainboard software number
Communication Fault (speed control module2)	E082	Speed control module and main board communication fail	Check the communication connection
Syst2:HP Protection	E21	The high-pressure switch is broken	Check the pressure switch and cold circuit
Syst2:LP Protection	E22	The low-pressure switch is broken	Check the pressure switch and cold circuit
Syst2:Antifreeze	E271	Use side water system temp. is low	1. Check the water temp. or change the temp. Sensor 2. Check the pipe water flow and whether water system is jammed or not
Fan Motor1 Overload Prot	E103	The fan motor is overload	Check whether the fan motor running normally
Fan Motor2 Overload Prot	E203	The fan motor is overload	Check whether the fan motor running normally
Inlet Water Temp Sensor Fault of Air-Conditioning	P013	The temp. Sensor is broken or short circuit	Check or change the temp. Sensor
Outlet Water Temp Sensor Fault of Air-Conditioning	P023	The temp. Sensor is broken or short circuit	Check or change the temp. Sensor
Outlet Water Temp Sensor Fault of Water mixer	P02a	The temp. Sensor is broken or short circuit	Check or change the temp. Sensor
Inlet Water Temp Sensor Fault of Hot Water	P018	The temp. Sensor is broken or short circuit	Check or change the temp. Sensor
Outlet Water Temp Sensor Fault of Hot Water	P028	The temp. Sensor is broken or short circuit	Check or change the temp. Sensor
Communication Fault with Hydraulic Module	E08c	Hydraulic Module and main board communication fail	Check the communication connection
Excess Water Temp Diff Prot.	E06	The water flow of the system is insufficient, the pressure difference of the water system is small	Inspect whether the water flow of the water pipe conforms to related requirements and check the water pump for any blockage
Distributor Tube Temp Sensor Fault	P152	The temperature sensor is open or short circuited	Check and replace the coil outlet temperature sensor

Operation and Use

Frequency conversion board fault table:

Protect/fault	Fault display	Reason	Elimination methods
IPM Overcurrent Shutdown Fault	F00	IPM Input current is large	Check and adjust the current measurement
Compressor Activation Failure	F01	Lack of phase, step or drive hardware damage	Check the measuring voltage check frequency conversion board hardware
Pre-Charge Failure	F03	The PFC circuit protection	Check the PFC switch tube short circuit or not
DC Bus Overload	F05	DC bus voltage>Dc bus Overload-voltage protection value	Check the input voltage measurement
DC Bus Underload	F06	DC bus voltage<Dc bus Underload-voltage protection value	Check the input voltage measurement
AC Input Underload	F07	The input voltage is low, causing the input current is low	Check the input voltage measurement
AC Input Overload	F08	The input voltage is too high, more than outage protection current RMS	Check the input voltage measurement
Input voltage Sample Fault	F09	The input voltage sampling fault	Check and adjust the current measurement
Comm. Err DSP-PFC	F10	DSP and PFC connect fault	Check the communication connection
Communication Fault (DSP)	F11	DSP and Inverter board communication failure	Check the communication connection
Communication Fault (Inverter Board)	F12	Frequency conversion board and main board communication failure	Check the communication connection
IPM Overheat Stop	F13	The IPM module is overheat	Check and adjust the current measurement
Compressor Overcurrent Shutdown Fault	E051	The compressor is overload	Check whether the system of the compressor running normally
Input voltage Lacking Phase	F15	The input voltage lost phase	Check and measure the voltage adjustment
IPM Current Sample Fault	F18	IPM sampling electricity is fault	Check and adjust the current measurement
Sensor Fault of Module/Radiator	F17	The transducer is overheat	Check and adjust the current measurement
IGBT Power Device Overheat Alarm	F20	The IGBT is overheat	Check and adjust the current measurement
Weak Magnetic Warn	F16	Compressor magnetic force is not enough	Check and adjust the current measurement
AC Input OverCurrent Alarm	F22	Input current is too large	Check and adjust the current measurement
EEPROM Error Warn	F23	MCU error	Check whether the chip is damaged Replace the chip
Destroyed EEPROM Activation Ban Alarm	F24	MCU error	Check whether the chip is damaged Replace the chip
V15V Over/Undervoltage Fault	F25	The V15V is overload or undervoltage	Check the V15V input voltage in range 13.5v~16.5v or not
IGBT Power Device Overheat Fault	F26	The IGBT is overheat	Check and adjust the current measurement
Compressor Current Frequency Reduction Alarm	F33	The Compressor Current Frequency Reduction	Check and adjust the current measurement

2.2 Parameter list

Meaning	Default	Remarks
Cooling target temperature set point	12°C	Adjustable
Heating the target temperature set point	40°C	Adjustable
Hot water target temperature set point	55°C	Adjustable

3. Interface diagram

3.1 Wire control interface diagram and definition

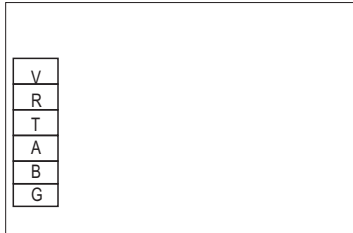

Sign	Meaning
V	12V (power +)
R	No use
T	No use
A	485A
B	485B
G	GND(power-)

3.2 Controller interface diagram and definition

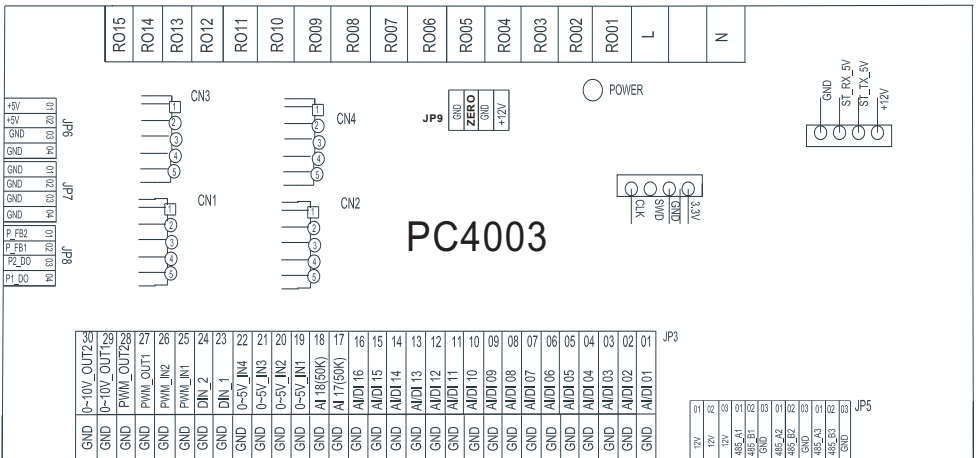

Operation and Use

Main board of the input and output interface instructions below

Number	Sign	Meaning
01	0~10V OUT1	No use
02	0~10V OUT2	No use
03	PWM_OUT1	AC switch output
04	PWM_OUT2	AC mode switch output
05	PWM_IN1	Water flow detection
06	PWM_IN2	No use
07	DIN_2	Remote Heat/Cool
08	DIN_1	Heat/Cool On/Off
09	0~5V_IN4	Pressure Sensor of system 1
10	0~5V_IN3	Current detection3
11	0~5V_IN2	Current detection2
12	0~5V_IN1	Current detection1
13	AI/18 (50k)	System Exhaust temperature 1
14	AI/17 (50K)	DHW On/Off
15	AI/DI16	Remote On/Off
16	AI/DI15	Electric heating overload input
17	AI/DI14	Water flow switch protection
18	AI/DI13	The low-preesure switch 1
19	AI/DI12	The high-preesure switch 1
20	AI/DI11	Temperature of the EVI outlet of system 1
21	AI/DI10	Temperature of the EVI inlet of system 1
22	AI/DI09	Room Temperature
23	AI/DI08	Water tank Temperature
24	AI/DI07	No use
25	AI/DI06	System1 Antifreeze 1 Temperature /Syetem 1 Coil temperature 2
26	AI/DI05	System 1 suction temperature
27	AI/DI04	Ambient temperature
28	AI/DI03	System 1 coil temperature
29	AI/DI02	Water output temperature
30	AI/DI01	Water input temperature
31	+5V	5V output
32	+12V	12V output
33	CN1	Electronic expansion valve 1 in system 1
34	CN2	Centralized control port
35	CN3	Electronic expansion valve of EVI in system 1
36	Cn4	No use
37	485_A1	Color screen/Inverter board/Hydraulic Module/
38	485_B1	DC fan speed regulation module
39	485_A2	Centralized control
40	485_B2	
41	485_A3	
42	485_B3	
		DTU

Operation and Use

43	RO15	No use
44	RO14	No use
45	RO13	No use
46	RO12	No use
47	RO11	No use
48	RO10	No use
50	RO09	No use
51	RO08	No use
52	RO07	No use
53	RO06	3-way valve
54	RO05	Electric Heating of Water Tank(Hydraulic Module)
55	RO04	Electric Heating of Waterway(Hydraulic Module)
56	RO03	Hot Water Pump
57	RO02	Air-Conditioning Pump
58	RO01	Main Circulation Pump

Appendix 1、 Caution & Warning

1. The unit can only be repaired by qualified installer centre personnel or an authorised dealer. (for Europe market)
2. This appliance is not intended for use by persons (including children) with reduced physical sensory or mental capabilities, or lack of experience and knowledge, unless they have been given supervision or instruction concerning use of the appliance by a person responsible for their safety. (for Europe market)
Children should be supervised to ensure that they do not play with the appliance.
3. Please make sure that the unit and power connection have good earthing, otherwise may cause electrical shock.
4. If the supply cord is damaged, it must be replaced by the manufacturer or our service agent or similarly qualified person in order to avoid a hazard.
5. Directive 2002/96/EC (WEEE):
The symbol depicting a crossed-out waste bin that is underneath the appliance indicates that this product, at the end of its useful life, must be handled separately from domestic waste, must be taken to a recycling centre for electric and electronic devices or handed back to the dealer when purchasing an equivalent appliance.
6. Directive 2002/95/EC (RoHs): This product is compliant with directive 2002/95/EC (RoHs) concerning restrictions for the use of harmful substances in electric and electronic devices.
7. The unit CANNOT be installed near the flammable gas. Once there is any leakage of the gas , fire can be occur.
8. Make sure that there is circuit breaker for the unit, lack of circuit breaker can lead to electrical shock or fire.
9. The heat pump located inside the unit is equipped with an over-load protection system. It does not allow for the unit to start for at least 3 minutes from a previous stoppage.
10. The unit can only be repaired by the qualified personnel of an installer center or an authorized dealer. (for North America market)
11. Installation must be performed in accordance with the NEC/CEC by authorized person only. (for North America market)
12. USE SUPPLY WIRES SUITABLE FOR 75°C.
13. Caution: Single wall heat exchanger, not suitable for potable water connection.

Appendix

Appendix 2、Cable specification

1. Single phase unit

Nameplate maximum current	Phase line	Earth line	MCB	Creepage protector	Signal line
No more than 10A	$2 \times 1.5\text{mm}^2$	1.5mm^2	20A	30mA less than 0.1 sec	$n \times 0.5\text{mm}^2$
10~16A	$2 \times 2.5\text{mm}^2$	2.5mm^2	32A	30mA less than 0.1 sec	
16~25A	$2 \times 4\text{mm}^2$	4mm^2	40A	30mA less than 0.1 sec	
25~32A	$2 \times 6\text{mm}^2$	6mm^2	40A	30mA less than 0.1 sec	
32~40A	$2 \times 10\text{mm}^2$	10mm^2	63A	30mA less than 0.1 sec	
40~63A	$2 \times 16\text{mm}^2$	16mm^2	80A	30mA less than 0.1 sec	
63~75A	$2 \times 25\text{mm}^2$	25mm^2	100A	30mA less than 0.1 sec	
75~101A	$2 \times 25\text{mm}^2$	25mm^2	125A	30mA less than 0.1 sec	
101~123A	$2 \times 35\text{mm}^2$	35mm^2	160A	30mA less than 0.1 sec	
123~148A	$2 \times 50\text{mm}^2$	50mm^2	225A	30mA less than 0.1 sec	
148~186A	$2 \times 70\text{mm}^2$	70mm^2	250A	30mA less than 0.1 sec	
186~224A	$2 \times 95\text{mm}^2$	95mm^2	280A	30mA less than 0.1 sec	

2. Three phase unit

Nameplate maximum current	Phase line	Earth line	MCB	Creepage protector	Signal line
No more than 10A	$3 \times 1.5\text{mm}^2$	1.5mm^2	20A	30mA less than 0.1 sec	$n \times 0.5\text{mm}^2$
10~16A	$3 \times 2.5\text{mm}^2$	2.5mm^2	32A	30mA less than 0.1 sec	
16~25A	$3 \times 4\text{mm}^2$	4mm^2	40A	30mA less than 0.1 sec	
25~32A	$3 \times 6\text{mm}^2$	6mm^2	40A	30mA less than 0.1 sec	
32~40A	$3 \times 10\text{mm}^2$	10mm^2	63A	30mA less than 0.1 sec	
40~63A	$3 \times 16\text{mm}^2$	16mm^2	80A	30mA less than 0.1 sec	
63~75A	$3 \times 25\text{mm}^2$	25mm^2	100A	30mA less than 0.1 sec	
75~101A	$3 \times 25\text{mm}^2$	25mm^2	125A	30mA less than 0.1 sec	
101~123A	$3 \times 35\text{mm}^2$	35mm^2	160A	30mA less than 0.1 sec	
123~148A	$3 \times 50\text{mm}^2$	50mm^2	225A	30mA less than 0.1 sec	
148~186A	$3 \times 70\text{mm}^2$	70mm^2	250A	30mA less than 0.1 sec	
186~224A	$3 \times 95\text{mm}^2$	95mm^2	280A	30mA less than 0.1 sec	

When the unit will be installed at outdoor, please use the cable which can against UV.



Designed by Cooper&Hunter International Corporation, Oregon, USA

www.cooperandhunter.com

E-mail: info@cooperandhunter.com

* Cooper&Hunter is constantly working to improve their products, so the information in this manual is subject to change without prior notice.