

EN

USER MANUAL



WATER DISPENSER



Model: CH-V115B

Please read the manual carefully before operating your water dispenser. Retain it for future reference.

DIRECTORY

SAFETY INSTRUCTION	1
PART NAME	2
OPERATION INSTRUCTION	3
CAUTION	3
TROUBLE SHOOTING	5
CLEANING	5
MACHINE INSTALLATION	6

The packaging material used is recyclable; we recommend that you separate plastic, paper and cardboard and give them to recycling companies. To help preserve the environment, the refrigerant used in this product is R134a (Hydrofluorocarbon -HFC), which does not affect the ozone layer and has little impact on the greenhouse effect. According to WEEE (Waste of Electrical and Electronic Equipment) guidelines, waste from electrical and electronic devices should be collected separately. If you need to dispose of this appliance in the future, do NOT throw it away with the rest of your domestic garbage. Instead, please take the appliance to the nearest WEEE collection point, where available.



SAFETY INSTRUCTION

1. This appliance can be used by children aged from 8 years and above and persons with reduced physical, sensory or mental capabilities or lack of experience and knowledge if they have been given supervision or instruction concerning use of the appliance in a safe way and understand the hazards involved. Children shall not play with the appliance.
Cleaning and user maintenance shall not be made by children without supervision.
2. This appliance is intended to be used by expert or trained users in shops, in light industry and on farms, or for commercial use by lay persons.
3. If the supply cord is damaged, it must be replaced by the manufacturer, its service agent or similarly qualified persons in order to avoid a hazard.
4. The appliance must not be cleaned by a water jet.
5. The appliance is suitable for indoor use only.
6. **WARNING:** Keep ventilation openings, in the appliance enclosure or in the built-in structure, clear of obstruction.
7. **WARNING:** Do not use mechanical devices or other means to accelerate the defrosting process, other than those recommended by the manufacturer.
8. **WARNING:** Do not use electrical appliances inside the food storage compartments of the appliance, unless they are of the type recommended by the manufacturer.
9. This series model dispenser can satisfy the need of tea & coffee and making cool drinking. It must be used indoor only.
10. With adoption of distinctive thermal isolation technology, this machine can minimize thermal exchange between hot & cold water.
11. **Warning:** Do not damage the refrigerant circuit.
12. Do not store explosive substances such as aerosol cans with a flammable propellant in this appliance.

PART NAME

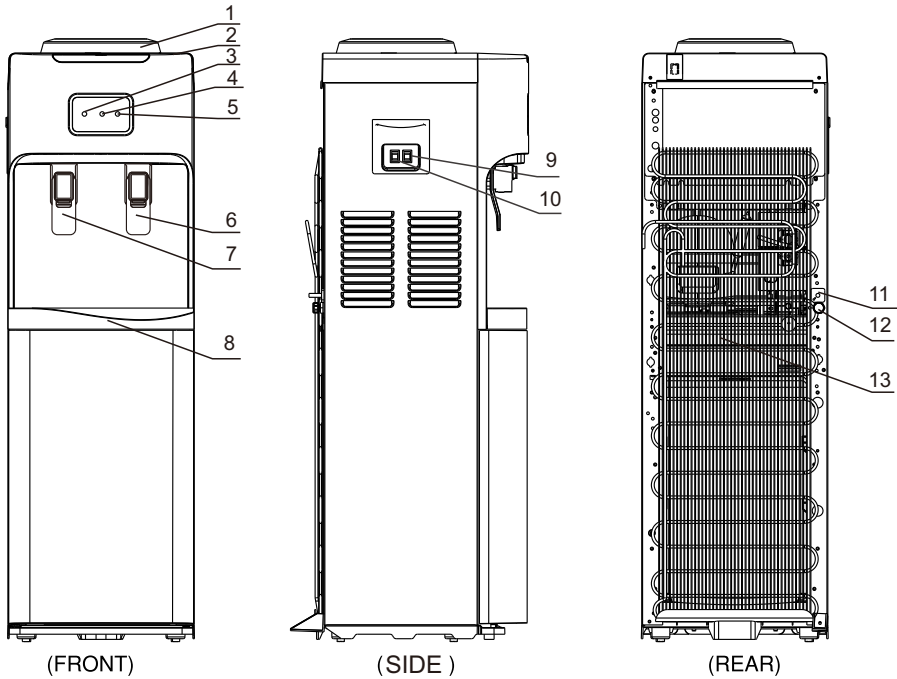

NO.	PART NAME	NO.	PART NAME
1	bottle supporter	8	water drip tray
2	top cover	9	heating switch
3	power pilot lamp	10	cooling switch
4	heating pilot lamp	11	power cord
5	cooling pilot lamp	12	hot water drain valve
6	faucet cold water	13	condenser
7	faucet of hot water		

NOTE:

This machine is suitable for gallons of 3 or 5 liters.
 Don't use unhealthy hard water.

OPERATION INSTRUCTION

1. Tear the label from the bottle.
2. Vertically insert the bottle into the bottle supporter on top of the machine. Don't plug the power cord or push the red switch until water runs out from the tap of hot water.
3. Insert the plug to socket, then turn on the power switch. Indicators light up accordingly once the machine works.
4. Vertically pull out the bottle by two hands when the bottle is empty, then replace it with another bottle of water.
5. This appliance should work under environment of temp from 10°C~43°C
6. This appliance is not suitable for installation in an area where a water jet could be used.

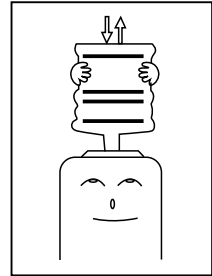

CAUTION

1. Keep this machine in place of dry and avoid direct sunshine. Rear of the machine should be at least 20cm far from the wall. Never put the machine on paper or foam, which may cause unstable condition, Never put anything flammable beside this machine.
2. To avoid damage to the machine, don't plug the power cord or turn on the heating switch (red) until water runs out from the tap of hot water.
3. In case hot (or cold) water is not needed for a long time, turn off the switch accordingly to save power.
4. In case not to use this machine for a long time, turn off the switches, then pull the plug out from socket and drain the remaining water through draining outlet.

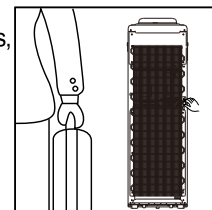
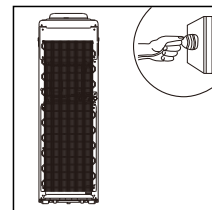
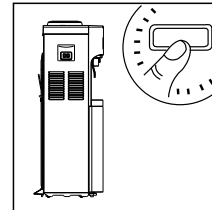
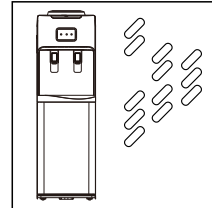

5. Never use organic liquid to clean the machine. Strictly prohibit splashing water to the unit.



6. Never turn on(off)the machine by plugging the plug to the (pulling the pulg out from) socket. Never increase the length of the power supply cord to avoid fire.

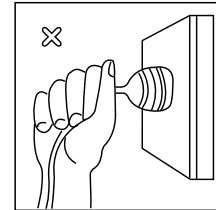

7. If the supply cord is damaged,it must be replaced by the manufacturer or its service agent or a similarly qualified person in order to avoid a hazard.

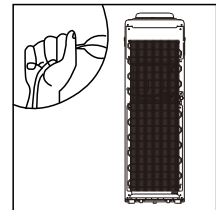

8. Never turn the machine upside down or tilt it more than 45°.

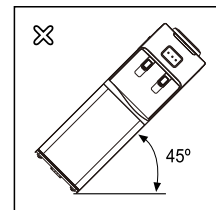

9. When the machine is under the ice point and blocked by ice, the cooling switch must be closed for 4 hours before turning it on again to continue its operation.

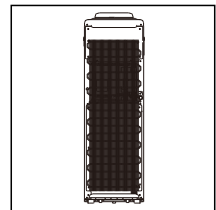

10. When using the fridge cabinet for the first time, let the cooling function operates about 2 hours before placing any product in the compartment. Never place wet or hot items in the compartment. Leave a suitable space between the products to ensure good air flow inside.

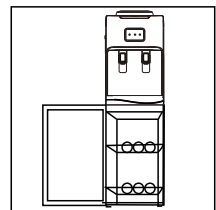

TROUBLE SHOOTING

Please check the follows before having the machine repaired.

PROBLEMS	POSSIBLE CAUSES	ELIMINATION
no hot or cold water	1. over consumption of hot or cold water in short time 2. no power supply	1. just wait a moment, then hot or cold water is available again. 2. connect plug to socket, turn on heating or cooling switch.
no water running out from taps	1.empty bottle 2.inlet of bottle supporter blocked by bottle seal	1.replace it with another one 2.clean out wasted paper & bottle seal, install bottle again.
leakage from bottle supporter	broken bottle	replace it with a new bottle
noisy operation	not placid installation	place the machine on placid & solid surface

CLEANING

To avoid accident, cut off the power supply before operation according to the following instruction.

1. The machine had been disinfected before departed from factory.
Cleaning the dispenser prior to installing a full bottle of water for the first time.
2. **Cleaning and draining instruction:**
 - ❶ Before cleaning, make sure the power switch in the **O(off)** position and unplug the water dispenser.
 - ❷ Vertically insert the bottle into the supporter on top of the machine.
 - ❸ Open the taps, let about 1 liter water flows into a container.
 - ❹ Removed the water bottle from the dispenser.
 - ❺ Place a large bucket beneath the drain outlet. Remove the drain cover and allow water to drain.
 - ❻ After draining, replace the drain cover and you can use the machine.
Attention: The dispenser heats water to a temperature of approximately 85°C. It can cause severe burns. Please operation it carefully.
3. **Sanitizing**
The machine should be disinfected with the disinfectant separately bought from drugstore or marketplace according to the instruction manual of the disinfectant and then clean it with water(see **cleaning and draining instruction**).Generally this should be done every three months.

4. To Remove Mineral Deposits:

Mix 4 liters water with 200g citric acid crystals, inject into the machine and make sure the water can flow out of the hot water tap. Switch on the power and heat it about 10 minutes, 30 minutes later, drain off the liquor and clean it with water for two or three times. Generally this should be done every six months.

Never disassemble this machine by yourself to avoid danger from damaged machine.

MACHINE INSTALLATION

Instructions for installation:

1. Use the screw to fix the bracket on the hole of the middle bottom of the water dispenser.
2. Make a hole on the floor's (or the desk's) surface where the water dispenser will be installed.
3. Fix the bracket on the floor by screw tightly.
4. Tighten the screw.

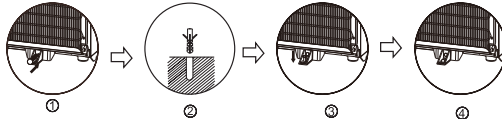
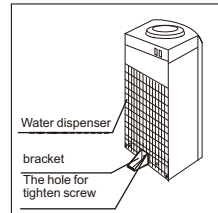

WARNING! To avoid a hazard due to instability of the appliance, it must be fixed in accordance with the instructions.

Designed by Cooper&Hunter International Corporation, Oregon, USA

www.cooperandhunter.com

E-mail: info@cooperandhunter.com

* Cooper & Hunter is constantly working to improve their products, so the information in this manual is subject to change without prior notice.