

# OWNER'S MANUAL



## Heat Pump Air To Air Split Air Conditioner ICY II Series



**MODELS:** CH-S09FTXTB2S-W  
CH-S12FTXTB2S-W  
CH-S18FTXTB2S-W  
CH-S24FTXTB2S-W

For proper operation, please read and keep this manual carefully.

Designed by Cooper&Hunter International Corporation, Oregon, USA  
[www.cooperandhunter.com](http://www.cooperandhunter.com)



### WARNING

#### **Operation and Maintenance**

- This appliance can be used by children aged from 8 years and above and persons with reduced physical, sensory or mental capabilities or lack of experience and knowledge if they have been given supervision or instruction concerning use of the appliance in a safe way and understand the hazards involved.
- Children shall not play with the appliance.
- Cleaning and user maintenance shall not be made by children without supervision.
- Do not connect air conditioner to multi-purpose socket. Otherwise, it may cause fire hazard.
- Do disconnect power supply when cleaning air conditioner. Otherwise, it may cause electric shock.
- If the supply cord is damaged, it must be replaced by the manufacturer, its service agent or similarly qualified persons in order to avoid a hazard.
- Do not wash the air conditioner with water to avoid electric shock.
- Do not spray water on indoor unit. It may cause electric shock or malfunction.
- After removing the filter, do not touch fins to avoid injury.
- Do not use fire or hair dryer to dry the filter to avoid deformation or fire hazard.

## Precautions



### WARNING

- Maintenance must be performed by qualified professionals. Otherwise, it may cause personal injury or damage.
- Do not repair air conditioner by yourself. It may cause electric shock or damage. Please contact dealer when you need to repair air conditioner.
- Do not extend fingers or objects into air inlet or air outlet. It may cause personal injury or damage.
- Do not block air outlet or air inlet. It may cause malfunction.
- Do not spill water on the remote controller, otherwise the remote controller may be broken.
- When below phenomenon occurs, please turn off air conditioner and disconnect power immediately, and then contact the dealer or qualified professionals for service.
  - Power cord is overheating or damaged.
  - There's abnormal sound during operation.
  - Circuit break trips off frequently.
  - Air conditioner gives off burning smell.
  - Indoor unit is leaking.
- If the air conditioner operates under abnormal conditions, it may cause malfunction, electric shock or fire hazard.
- When turning on or turning off the unit by emergency operation switch, please press this switch with an insulating object other than metal.
- Do not step on top panel of outdoor unit, or put heavy objects. It may cause damage or personal injury.

## Precautions



### WARNING

#### Attachment

- Installation must be performed by qualified professionals. Otherwise, it may cause personal injury or damage.
- Must follow the electric safety regulations when installing the unit.
- According to the local safety regulations, use qualified power supply circuit and circuit break.
- Do install the circuit break. If not, it may cause malfunction.
- An all-pole disconnection switch having a contact separation of at least 3mm in all poles should be connected in fixed wiring.
- Including an circuit break with suitable capacity, please note the following table. Air switch should be included magnet buckle and heating buckle function, it can protect the circuit-short and overload.
- Air Conditioner should be properly grounded. Incorrect grounding may cause electric shock.
- Don't use unqualified power cord.
- Make sure the power supply matches with the requirement of air conditioner. Unstable power supply or incorrect wiring or malfunction. Please install proper power supply cables before using the air conditioner.
- Properly connect the live wire, neutral wire and grounding wire of power socket.
- Be sure to cut off the power supply before proceeding any work related to electricity and safety.

## Precautions



### WARNING

- Do not put through the power before finishing installation.
- If the supply cord is damaged, it must be replaced by the manufacturer, its service agent or similarly qualified persons in order to avoid a hazard.
- The temperature of refrigerant circuit will be high, please keep the interconnection cable away from the copper tube.
- The appliance shall be installed in accordance with national wiring regulations.
- Installation must be performed in accordance with the requirement of NEC and CEC by authorized personnel only.
- The air conditioner is the first class electric appliance. It must be properly grounding with specialized grounding device by a professional. Please make sure it is always grounded effectively, otherwise it may cause electric shock.
- The yellow-green wire in air conditioner is grounding wire, which can't be used for other purposes.
- The grounding resistance should comply with national electric safety regulations.
- The appliance must be positioned so that the plug is accessible.
- All wires of indoor unit and outdoor unit should be connected by a professional.
- If the length of power connection wire is insufficient, please contact the supplier for a new one. Avoid extending the wire by yourself.

## Precautions



### WARNING

- For the air conditioner with plug, the plug should be reachable after finishing installation.
- For the air conditioner without plug, an circuit break must be installed in the line.
- If you need to relocate the air conditioner to another place, only the qualified person can perform the work. Otherwise, it may cause personal injury or damage.
- Select a location which is out of reach for children and far away from animals or plants. If it is unavoidable, please add the fence for safety purpose.
- The indoor unit should be installed close to the wall.

### Working temperature range

|                 | Indoor side DB/WB(°C ) | Outdoor side DB/WB(°C ) |
|-----------------|------------------------|-------------------------|
| Maximum cooling | 32/23                  | 43/26                   |
| Maximum heating | 27/-                   | 24/18                   |

### **NOTICE:**

- The operating temperature range (outdoor temperature) for cooling only unit is -15°C ~48°C ; for heat pump unit is -30°C ~ 48°C .

# Parts Name

## Indoor Unit

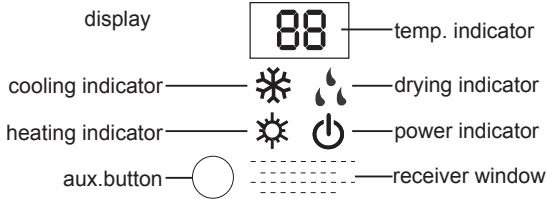
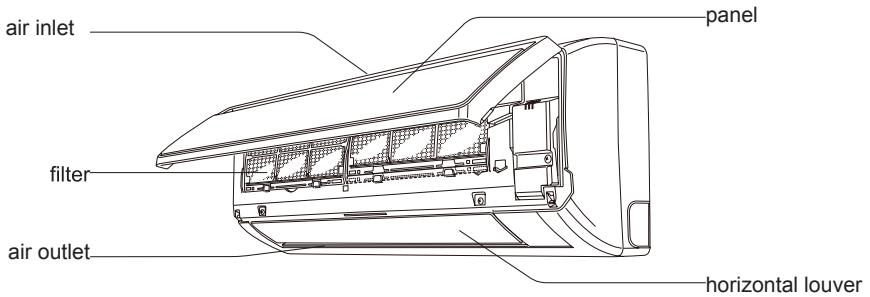

remote controller

(Display content or position may be different from above graphics, please refer to actual products)

## Outdoor Unit

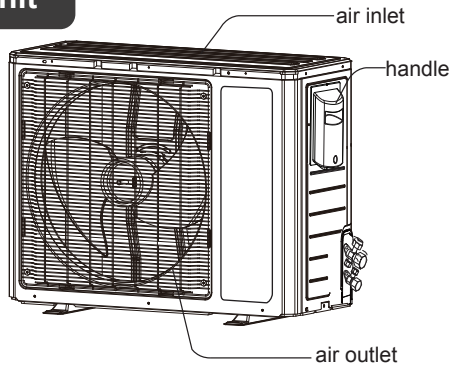

### **NOTICE:**

Actual product may be different from above graphics, please refer to actual products.

# Buttons on remote controller

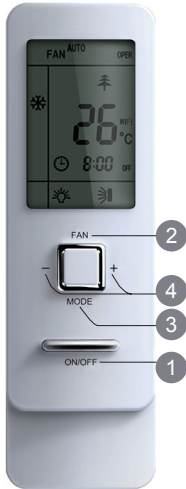

(before opening cover)



(after opening cover)

- 1 ON/OFF button
- 2 FAN button
- 3 MODE button
- 4 +/- button

- 1 ON/OFF button
- 2 FAN button
- 3 MODE button +/- button
- 4
- 5 TURBO button
- 6 button
- 7 button
- 8 CLOCK button
- 9 TIMER ON/TIMER OFF button
- 10 TEMP button
- 11 button
- 12 I FEEL button
- 13 LIGHT button
- 14 X-FAN button
- 15 QUIET button
- 16 SLEEP button

# Introduction for icons on display screen

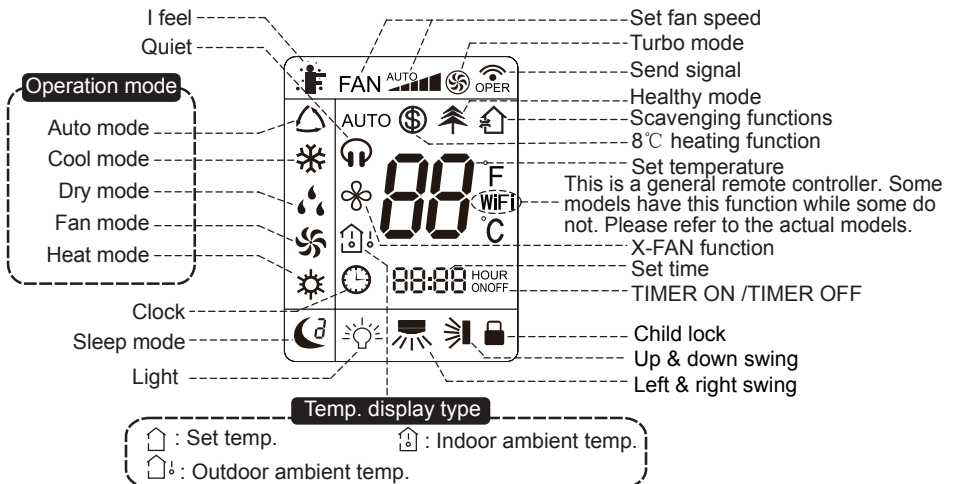



# Introduction for buttons on remote controller

## Note:

- This is a general use remote controller, it could be used for the air conditioners with multifunction; For some function, which the model don't have, if press the corresponding button on the remote controller that the unit will keep the original running status.
- After putting through the power, the air conditioner will give out a sound. Operation indicator "⏻" is ON (red indicator). After that, you can operate the air conditioner by using remote controller.
- Under on status, pressing the button on the remote controller, the signal icon "📶" on the display of remote controller will blink once and the air conditioner will give out a "de" sound, which means the signal has been sent to the air conditioner.
- Under off status, set temperature and clock icon will be displayed on the display of remote controller (If timer on, timer off and light functions are set, the corresponding icons will be displayed on the display of remote controller at the same time); Under on status, the display will show the corresponding set function icons.

## 1 ON/OFF button

Press this button, the unit will be turned on, press it once more, the unit will be turned off. Sleep function will be canceled, while unit off.

## 2 FAN button

Press this button, Auto, Low, Medium-low, Medium, Medium-high, High speed can be circularly selected. After powered on, Auto fan speed is default. Under DRY mode, Low fan speed only can be set up.



Note: It's Low fan speed under Dry mode.

Note: If matching with smart zone controller for operation, under auto fan speed, the fan speed display on smart zone controller will always be maintained at "auto high fan".

## 3 MODE button

Press this button, Auto, Cool, Dry, Fan, Heat mode can be selected circularly. Auto mode is default while power on. Under Auto mode, the temperature will not be displayed; Under Heat mode, the initial value is 28°C (82°F); Under other modes, the initial value is 25°C (77°F).



(only for cooling and heating unit. As for cooling only unit, it won't have any action

## 4 +/- button

- Presetting temperature can be increased. Press this button, the temperature can be set up, continuously press this button and hold for two seconds, the relative contents can quickly change, until unhold this button and send the order that the °C (°F) signal will be displayed all the time. The temperature adjustment is unavailable under the Auto mode, but the order can be sent if pressing this button. Temperature of Celsius degree setting: 16-30; for Fahrenheit degree setting: 61-86.

# Introduction for buttons on remote controller

- Presetting temperature can be decreased. Press this button, the temperature can be set up, continuously press this button and hold for two seconds, the relative contents can quickly change, until unhold this button and send the order that the °C (°F) signal will be displayed all the time. The temperature adjustment is unavailable under the Auto mode, but the order can be sent by if pressing this button.

## 5 TURBO button

Under Cool or Heat mode, press this button can turn on or turn off the Turbo function. After the Turbo function turned on, the signal of Turbo will display. The signal will be automatically cancelled if changing the mode or fan speed.

## 6 button (OPTION)

Press this button to set left & right swing angle cycling as below:

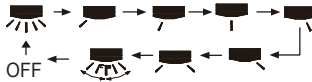

## 7 button

Press this button to set swing angle, which circularly changes as below:







This remote controller is universal. If it receives three kinds of following status, the swing angle will remain original.



If guide louver is stopped when it is swinging up and down, it will remain its present position.

 indicates guide louver swings back and forth in the five places, as shown in the figure.

## 8 CLOCK button

Press this button, the clock can be set up, signal  blink and display. Within 5 seconds, the value can be adjusted by pressing + or - button, if continuously press this button for 2 seconds above, in every 0.5 seconds, the value on ten place of Minutewill be increased 1. During blinking, repress the Clock button or Confirm button, signal  will be constantly displayed and it denotes the setting succeeded. After powered on, 12:00 is defaulted to display and signal  will be displayed. If there is signal  be displayed that denotes the current time value is Clock value, otherwise is Timer value.

## 9 TIMER ON/TIMER OFF button

- Timer On setting: Sign al “ON” will blink and display, signal  will conceal, the numerical section will become the timer on setting status. During 5 seconds blink, by pressing + or - button to adjust the time value of numerical section, every press of that button, the value will be increased or decreased 1 minute. Hold pressing + or -

# Introduction for buttons on remote controller

button, 2 seconds later, it quickly change, the way of change is: During the initial 2.5 seconds, ten numbers change in the one place of minute, then the one place is constant, ten numbers change in the tens place of minute at 2.5 seconds speed and carry. During 5s blink, press the Timer button, the timer setting succeeds. The Timer On has been set up, repress the timer button, the Timer On will be canceled. Before setting the Timer, please adjust the Clock to the current actual time.

- One press this key to enter into TIMER OFF setup, in which case the TIMER OFF icon will blink. The method of setting is the same as for TIMER ON.

## 10 TEMP button

- Press this button, you can see indoor set temperature, indoor ambient temperature or outdoor ambient temperature on indoor unit's display. The setting on remote controller is selected circularly as below:

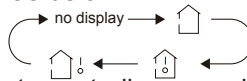

- When selecting "house icon with thermometer" with remote controller or no display, temperature indicator on indoor unit displays set temperature; When selecting "house icon with thermometer and plus sign" with remote controller, temperature indicator on indoor unit displays indoor ambient temperature; When selecting "house icon with thermometer and minus sign" with remote controller, temperature indicator on indoor unit displays outdoor ambient temperature. 3s later it will return to the setting temperature or it depends on the other received signal within 3s.

Attention: When displaying the outdoor ambient, the displaying range is 0-60°C. When it goes beyond the range, it keeps the threshold data (the smallest—0°C and the largest 60°C).

Warm tips: When operating buttons on the cover please make sure the cover is closed completely.

## 11 Healthy/Scavenging button

Press this button to achieve the on and off of healthy and scavenging functions in operation status. Press this button for the first time to start scavenging function; LCD displays "house icon with thermometer". Press the button for the second time to start healthy and scavenging functions simultaneously; LCD displays "house icon with thermometer and plus sign" and "house icon with thermometer and minus sign". Press this button for the third time to quit healthy and scavenging functions simultaneously. Press the button for the fourth time to start healthy function; LCD display "house icon with thermometer and plus sign". Press this button again to repeat the operation above.

NOTE: This function is applicable to partial of models.

## 12 I FEEL button

Press this button once, to turn on the I FEEL function, then the figure of "I FEEL" will be displayed, after every press of other function button, every 200ms to send I FEEL once, after this function started, the remote controller will send temperature to the main unit in every 10 minutes. When repress this button, this function will be turned off.

# Introduction for buttons on remote controller





## 13 LIGHT button

Press this button at unit On or Off status, Light On and Light Off can be set up. After powered on, Light On is defaulted.



## 14 X-FAN button

Pressing X-FAN button in COOL or DRY mode, the icon  is displayed and the indoor fan will continue operation for 2 minutes in order to dry the indoor unit even though you have turned off the unit. After energization, X-FAN OFF is defaulted. X-FAN is not available in AUTO, FAN or HEAT mode.

## 15 QUIET button

Press this button, the Quiet status is under the Auto Quiet mode (display " " and "Auto" signal) and Quiet mode (display " " signal) and Quiet OFF (there is no signal of " " displayed), after powered on, the Quiet OFF is defaulted. Under the Quiet mode (Display " " signal).

## 16 SLEEP button

- Press this button, can select Sleep 1 (), Sleep 2 (), Sleep 3 () and cancel the Sleep, circulate between these, after electrified, Sleep Cancel is defaulted.
- Sleep 1 is Sleep mode 1, in Cool, Dehumidify modes: sleep status after run for one hour, the main unit setting temperature will increase 1°C, 2 hours, setting temperature increased 2°C, the unit will run at this setting temperature; In Heat mode: sleep status after run for one hour, the setting temperature will decrease 1°C, 2 hours, setting temperature will decrease 2°C, then the unit will run at this setting temperature.
- Sleep 2 is sleep mode 2, that is air conditioner will run according to the presetting a group of sleep temperature curve.

In Cool mode:

- (1) When setting the initial temperature 16°C-23°C, after turned on Sleep function, the temperature will be increased 1°C in every hour, after 3°C the temperature will be maintained, after 7hours, the temperature will be decreased 1°C, after that the unit will keep on running under this temperature;
- (2) When setting the initial temperature 24°C-27°C, after turned on Sleep function, the temperature will be increased 1°C in every hour, after 2°C the temperature will be maintained, after 7hours, the temperature will be decreased 1°C, after that the unit will keep on running under this temperature;
- (3) When setting the initial temperature 28°C-29°C, after turned on Sleep function, the temperature will be increased 1°C in every hour, after 1°C the temperature will be maintained, after 7hours, the temperature will be decreased 1°C, after that the unit will keep on running under this temperature;

# Introduction for buttons on remote controller

(4) When setting the initial temperature 30°C, under this temperature setting, after 7hours, the temperature will be decreased 1°C, after that the unit will keep on running under this temperature;

In Heat mode:

- (1) Under the initial presetting temperature 16°C, it will run under this setting temperature all along.
- (2) Under the initial presetting temperature 17°C-20°C, after Sleep function started up, the temperature will decrease 1°C in every hour, after 1°C decreased, this temperature will be maintained.
- (3) Under the initial presetting temperature 21°C-27°C, after Sleep function started up, the temperature will decrease 1°C in every hour, after 2°C decreased, this temperature will be maintained.
- (4) Under the initial presetting temperature 28°C-30°C, after Sleep function started up, the temperature will decrease 1°C in every hour, after 3°C decreased, this temperature will be maintained.

• Sleep 3 - the sleep curve setting under Sleep mode by DIY:

- (1) Under Sleep 3 mode, press "Turbo" button for a long time, remote controller enters into user individuation sleep setting status, at this time, the time of remote controller will display "1hour", the setting temperature "88" will display the corresponding temperature of last setting sleep curve and blink (The first entering will display according to the initial curve setting value of original factory);
- (2) Adjust "+" and "-" button, could change the corresponding setting temperature, after adjusted, press "Turbo" button for confirmation;
- (3) At this time, 1hour will be automatically increased at the timer position on the remote controller, (that are "2hours" or "3hours" or "8hours"), the place of setting temperature "88" will display the corresponding temperature of last setting sleep curve and blink;
- (4) Repeat the above step (2)~(3) operation, until 8hours temperature setting finished, sleep curve setting finished, at this time, the remote controller will resume the original timer display; temperature display will resume to original setting temperature.

• Sleep3 - the sleep curve setting under Sleep mode by DIY could be inquired:

The user could accord to sleep curve setting method to inquire the presetting sleep curve, enter into user individuation sleep setting status, but do not change the temperature, press "Turbo" button directly for confirmation.

Note: In the above presetting or enquiry procedure, if continuously within 10s, there is no button pressed, the sleep curve setting status will be automatically quit and resume to display the original displaying. In the presetting or enquiry procedure, press "ON/OFF" button, "Mode" button, "Timer" button or "Sleep" button, the sleep curve setting or enquiry status will quit similarly.

# Introduction for special function

## About X-FAN function

This function indicates that moisture on evaporator of indoor unit will be blown after the unit is stopped to avoid mould.

1. Having set X-FAN function on: After turning off the unit by pressing ON/OFF button indoor fan will continue running for about 2 min. at low speed. In this period, press X-FAN button to stop indoor fan directly.
2. Having set X-FAN function off: After turning off the unit by pressing ON/OFF button, the complete unit will be off directly.

## About AUTO RUN

When AUTO RUN mode is selected, the setting temperature will not be displayed on the LCD, the unit will be in accordance with the room temp. automatically to select the suitable running method and to make ambient comfortable.



## About turbo function

If start this function, the unit will run at super-high fan speed to cool or heat quickly so that the ambient temp. approaches the preset temp. as soon as possible.



## About lock

Press + and - buttons simultaneously to lock or unlock the keyboard. If the remote controller is locked, the icon  will be displayed on it, in which case, press any button, the mark will flicker for three times. If the keyboard is unlocked, the mark will disappear.

## About swing up and down

1. Press swing up and down button continuously more than 2s, the main unit will swing back and forth from up to down, and then loosen the button, the unit will stop swing and present position of guide louver will be kept immediately.
2. Under swing up and down mode, when the status is switched from off to , if press this button again 2s later,  status will switch to off status directly; if press this button again within 2s, the change of swing status will also depend on the circulation sequence stated above.

## About swing left and right

1. Press swing left and right button continuously more than 2s, the main unit will swing back and forth from left to right, and then loosen the button, the unit will stop swing and present position of guide louver will be kept immediately.
2. Under swing left and right mode, when the status is switched from off to , if press this button again 2s later,  status will switch to off status directly; if press this button again within 2s, the change of swing status will also depend on the circulation sequence stated above.

# Introduction for special function

## About switch between Fahrenheit and Centigrade

Under status of unit off, press MODE and - buttons simultaneously to switch °C and °F.

## Combination of "TEMP" and "CLOCK" buttons: About Energy - saving Function

Press "TEMP" and "CLOCK" simultaneously in COOL mode to start energy-saving function. Nixie tube on the remote controller displays "SE". Repeat the operation to quit the function.

## Combination of "TEMP" and "CLOCK" buttons: About 8°C Heating Function

Press "TEMP" and "CLOCK" simultaneously in HEAT mode to start 8°C Heating Function. Nixie tube on the remote controller displays "Ⓔ" and a selected temperature of "8°C". (46°F if Fahrenheit is adopted). Repeat the operation to quit the function.

Note: If matching with smart zone controller for operation, the display on smart zone controller will be maintained the original status.

## About auto Quiet function

When quiet function is selected:

1. Under cooling mode: indoor fan operates at notch 4 speed. 10 minutes later or when indoor ambient temperature  $\leq 28^{\circ}\text{C}$ , indoor fan will operate at notch 2 speed or quiet mode according to the comparison between indoor ambient temperature and set temperature.
2. Under heating mode: indoor fan operates at notch 3 speed or quiet mode according to the comparison between indoor ambient temperature and set temperature.
3. Under dry, fan mode: indoor fan operates at quiet mode.
4. Under auto mode: the indoor fan operates at the auto quiet mode according to actual cooling, heating or fan mode.

## About Sleep function



Under the Fan and Auto mode, the Sleep function cannot be set up, under Dehumidify mode, only Sleep 1 can be selected. Select and enter into any kind of Sleep mode, the Quiet function will be attached and started, different Quiet status could be optional and turned off.

## WIFI Function

Press "MODE" and "TURBO" button simultaneously to turn on or turn off WIFI function. When WIFI function is turned on, the "WiFi" icon will be displayed on remote controller; Long press "MODE" and "TURBO" buttons simultaneously for 10s, remote controller will send WIFI reset code and then the WIFI function will be turned on. WIFI function is defaulted ON after energization of the remote controller. (This function only applicable for some models. )

# Operation guide

## General operation

1. After powered on, press ON/OFF button, the unit will start to run. (Note: When it is powered on, the guide louver of main unit will close automatically.)
2. Press MODE button, select desired running mode.
3. Pressing + or - button, to set the desired temperature (It is unnecessary to set the temp. at AUTO mode.)
4. Pressing FAN button, set fan speed, can select AUTO FAN, LOW, MEDIUM-LOW, MEDIUM, MEDIUM-HIGH and HIGH.
5. Pressing  and  button, to select the swing.

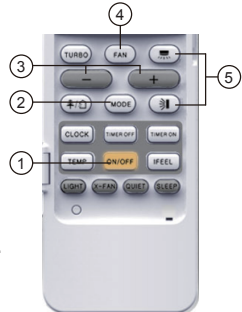

## Optional operation

1. Press SLEEP button, to set sleep.
2. Press TIMER ON and TIMER OFF button, can set the scheduled timer on or timer off.
3. Press LIGHT button, to control the on and off of the displaying part of the unit (This function may be not available for some units).
4. Press TURBO button, can realize the ON and OFF of TURBO function.

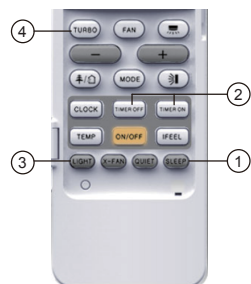

# Replacement of batteries in remote controller

1. Press the back side of remote controller marked with "⊞", as shown in the fig, and then push out the cover of battery box along the arrow direction.
2. Replace two 7# (AAA 1.5V) dry batteries, and make sure the position of "+" polar and "-" polar are correct.
3. Reinstall the cover of battery box.

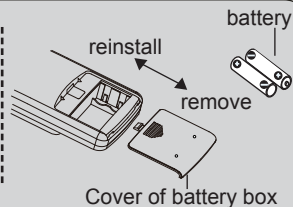

## NOTICE

- During operation, point the remote control signal sender at the receiving window on indoor unit.
- The distance between signal sender and receiving window should be no more than 8m, and there should be no obstacles between them.
- Signal may be interfered easily in the room where there is fluorescent lamp or wireless telephone; remote controller should be close to indoor unit during operation.
- Replace new batteries of the same model when replacement is required.
- When you don't use remote controller for a long time, please take out the batteries.
- If the display on remote controller is fuzzy or there's no display, please replace batteries.



## Emergency operation

If remote controller is lost or damaged, please use auxiliary button to turn on or turn off the air conditioner. The operation in details are as below: As shown in the fig. press aux. button to turn on or turn off the air conditioner. When the air conditioner is turned on, it will operate under auto mode.

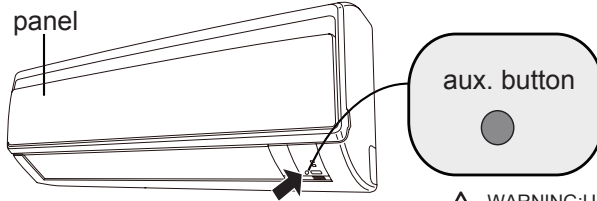

 **WARNING:** Use insulated object to press the auto button

## Clean and maintenance

### **WARNING**

- Turn off the air conditioner and disconnect the power before cleaning the air conditioner to avoid electric shock.
- Do not wash the air conditioner with water to avoid electric shock.
- Do not use volatile liquid to clean the air conditioner.

### Clean surface of indoor unit

When the surface of indoor unit is dirty, it is recommended to use a soft dry cloth or wet cloth to wipe it.

### **NOTICE:**

- Do not remove the panel when cleaning it.

# Clean and maintenance

## Clean filter

### 1 Open panel

Pull out the panel to a certain angle as shown in the fig.

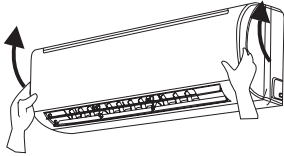

### 2 Remove filter

Remove the filter as indicated in the fig.

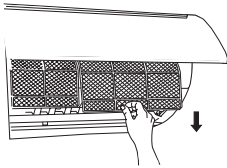

### 3 Clean filter

- Use dust catcher or water to clean the filter.
- When the filter is very dirty, use

the water (below 45°C ) to clean it, and then put it in a shady

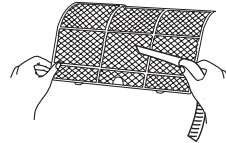

### 4 Install filter

Install the filter and then close the panel cover tightly.

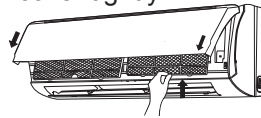

## WARNING

- The filter should be cleaned every three months. If there is much dust in the operation environment, clean frequency can be increased.
- After removing the filter, do not touch fins to avoid injury.
- Do not use fire or hair dryer to dry the filter to avoid deformation or fire hazard.

# Clean and Maintenance

## **NOTICE: Checking before use-season**

1. Check whether air inlets and air outlets are blocked.
2. Check whether air switch, plug and socket are in good condition.
3. Check whether filter is clean.
4. Check whether mounting bracket for outdoor unit is damaged or corroded.  
If yes, please contact dealer.
5. Check whether drainage pipe is damaged.

## **NOTICE: Checking after use-season**

1. Disconnect power supply.
2. Clean filter and indoor unit's panel.
3. Check whether mounting bracket for outdoor unit is damaged or corroded.  
If yes, please contact dealer.

## **Notice for recovery**

1. Many packing materials are recyclable materials.  
Please dispose them in appropriate recycling unit.
2. If you want to dispose the air conditioner, please contact local dealer or consultant service center for the correct disposal method.

# Malfunction analysis

## General phenomenon analysis

Please check below items before asking for maintenance. If the malfunction still can't be eliminated, please contact local dealer or qualified professionals.

| Phenomenon   | Check items  | Solution  |
|--|--|---|
| Indoor unit can't receive remote controller's signal or remote controller has no action. | <ul style="list-style-type: none"> <li>Whether it's interfered severely (such as static electricity, stable voltage)?</li> </ul> | <ul style="list-style-type: none"> <li>Pull out the plug. Reinsert the plug after about 3min, and then turn on the unit again.</li> </ul>   |
|  | <ul style="list-style-type: none"> <li>Whether remote controller is within the signal receiving range?</li> </ul>                | <ul style="list-style-type: none"> <li>Signal receiving range is 8m.</li> </ul>   |
|  | <ul style="list-style-type: none"> <li>Whether there are obstacles?</li> </ul>   | <ul style="list-style-type: none"> <li>Remove obstacles.</li> </ul>   |
|  | <ul style="list-style-type: none"> <li>Whether remote controller is pointing at the receiving window?</li> </ul>                 | <ul style="list-style-type: none"> <li>Select proper angle and point the remote controller at the receiving window on indoor unit.</li> </ul>   |
|  | <ul style="list-style-type: none"> <li>Is sensitivity of remote controller low; fuzzy display and no display?</li> </ul>         | <ul style="list-style-type: none"> <li>Check the batteries. If the power of batteries is too low, please replace them.</li> </ul>   |
|  | <ul style="list-style-type: none"> <li>No display when operating remote controller?</li> </ul>                                   | <ul style="list-style-type: none"> <li>Check whether remote controller appears to be damaged. If yes, replace it.</li> </ul>  |
|  | <ul style="list-style-type: none"> <li>Fluorescent lamp in room?</li> </ul>  | <ul style="list-style-type: none"> <li>Take the remote controller close to indoor unit.</li> <li>Turn off the fluorescent lamp and then try it again.</li> </ul>                          |
| No air emitted from indoor unit  | <ul style="list-style-type: none"> <li>Air inlet or air outlet of indoor unit is blocked?</li> </ul>                             | <ul style="list-style-type: none"> <li>Eliminate obstacles.</li> </ul>  |
|  | <ul style="list-style-type: none"> <li>Under heating mode, indoor temperature is reached to set temperature?</li> </ul>          | <ul style="list-style-type: none"> <li>After reaching to set temperature, indoor unit will stop blowing out air.</li> </ul>   |
|  | <ul style="list-style-type: none"> <li>Heating mode is turned on just now?</li> </ul>  | <ul style="list-style-type: none"> <li>In order to prevent blowing out cold air, indoor unit will be started after delaying for several minutes, which is a normal phenomenon.</li> </ul> |

# Malfunction analysis

| Phenomenon                                    | Check items  | Solution   |
|---|--|--|
| Air conditioner can't operate                 | • Power failure?   | • Wait until power recovery.   |
|   | • Is plug loose?   | • Reinsert the plug.   |
|   | • Air switch trips off or fuse is burnt out?                     | • Ask professional to replace air switch or fuse.  |
|   | • Wiring has malfunction?  | • Ask professional to replace it.  |
|   | • Unit has restarted immediately after stopping operation?       | • Wait for 3min, and then turn on the unit again.  |
|   | • Whether the function setting for remote controller is correct? | • Reset the function.  |
| Mist is emitted from indoor unit's air outlet | • Indoor temperature and humidity is high?                       | • Because indoor air is cooled rapidly. After a while, indoor temperature and humidity will be decrease and mist will disappear. |
| Set temperature can't be adjusted             | • Unit is operating under auto mode?                             | • Temperature can't be adjusted under auto mode. Please switch the operation mode if you need to adjust temperature.             |
|   | • Your required temperature exceeds the set temperature range?   | • Set temperature range: 16°C ~30°C .  |
| Cooling (heating) effect is not good.         | • Voltage is too low?  | • Wait until the voltage resumes normal.   |
|   | • Filter is dirty?   | • Clean the filter.  |
|   | • Set temperature is in proper range?                            | • Adjust temperature to proper range.  |
|   | • Door and window are open?                                      | • Close door and window.   |

# Malfunction analysis

| Phenomenon                                 | Check items   | Solution   |
|--|---|--|
| Odours are emitted                         | <ul style="list-style-type: none"><li>• Whether there's odour source, such as furniture and cigarette, etc.</li></ul>   | <ul style="list-style-type: none"><li>• Eliminate the odour source.</li><li>• Clean the filter.</li></ul>  |
| Air conditioner operates normally suddenly | <ul style="list-style-type: none"><li>• Whether there's interference, such as thunder, wireless devices, etc.</li></ul> | <ul style="list-style-type: none"><li>• Disconnect power, put back power, and then turn on the unit again.</li></ul>   |
| Outdoor unit has vapor                     | <ul style="list-style-type: none"><li>• Heating mode is turned on?</li></ul>  | <ul style="list-style-type: none"><li>• During defrosting under heating mode, it may generate vapor, which is a normal phenomenon.</li></ul>                                     |
| "Water flowing" noise                      | <ul style="list-style-type: none"><li>• Air conditioner is turned on or turned off just now?</li></ul>                  | <ul style="list-style-type: none"><li>• The noise is the sound of refrigerant flowing inside the unit, which is a normal phenomenon.</li></ul>                                   |
| Cracking noise                             | <ul style="list-style-type: none"><li>• Air conditioner is turned on or turned off just now?</li></ul>                  | <ul style="list-style-type: none"><li>• This is the sound of friction caused by expansion and/or contraction of panel or other parts due to the change of temperature.</li></ul> |

# Malfunction analysis

## Error Code

- When air conditioner status is abnormal, temperature indicator on indoor unit will blink to display corresponding error code. Please refer to below list for identification of error code.

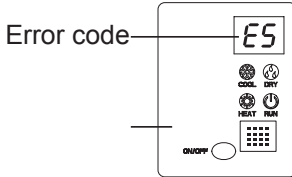

Above indicator diagram is only for reference. Please refer to actual product for the actual indicator and position.

| Error code | Troubleshooting   |
|------------|---|
| H1         | Means defrosting status. It's the normal phenomenon.  |
| E5         | It can be eliminated after restarting the unit. If not, please contact qualified professionals for service. |
| H4         | It can be eliminated after restarting the unit. If not, please contact qualified professionals for service. |
| U8         | It can be eliminated after restarting the unit. If not, please contact qualified professionals for service. |
| H6         | It can be eliminated after restarting the unit. If not, please contact qualified professionals for service. |
| C5         | Please contact qualified professionals for service.   |
| F1         | Please contact qualified professionals for service.   |
| F2         | Please contact qualified professionals for service.   |

Note: If there're other error codes, please contact qualified professionals for service.

## WARNING

- When below phenomenon occurs, please turn off air conditioner and disconnect power immediately, and then contact the dealer or qualified professionals for service.
  - Power cord is overheating or damaged.
  - There's abnormal sound during operation.
  - Circuit break trips off frequently.
  - Air conditioner gives off burning smell.
  - Indoor unit is leaking.
- Do not repair or refit the air conditioner by yourself.
- If the air conditioner operates under abnormal conditions, it may cause malfunction, electric shock or fire hazard.

# Installation dimension diagram

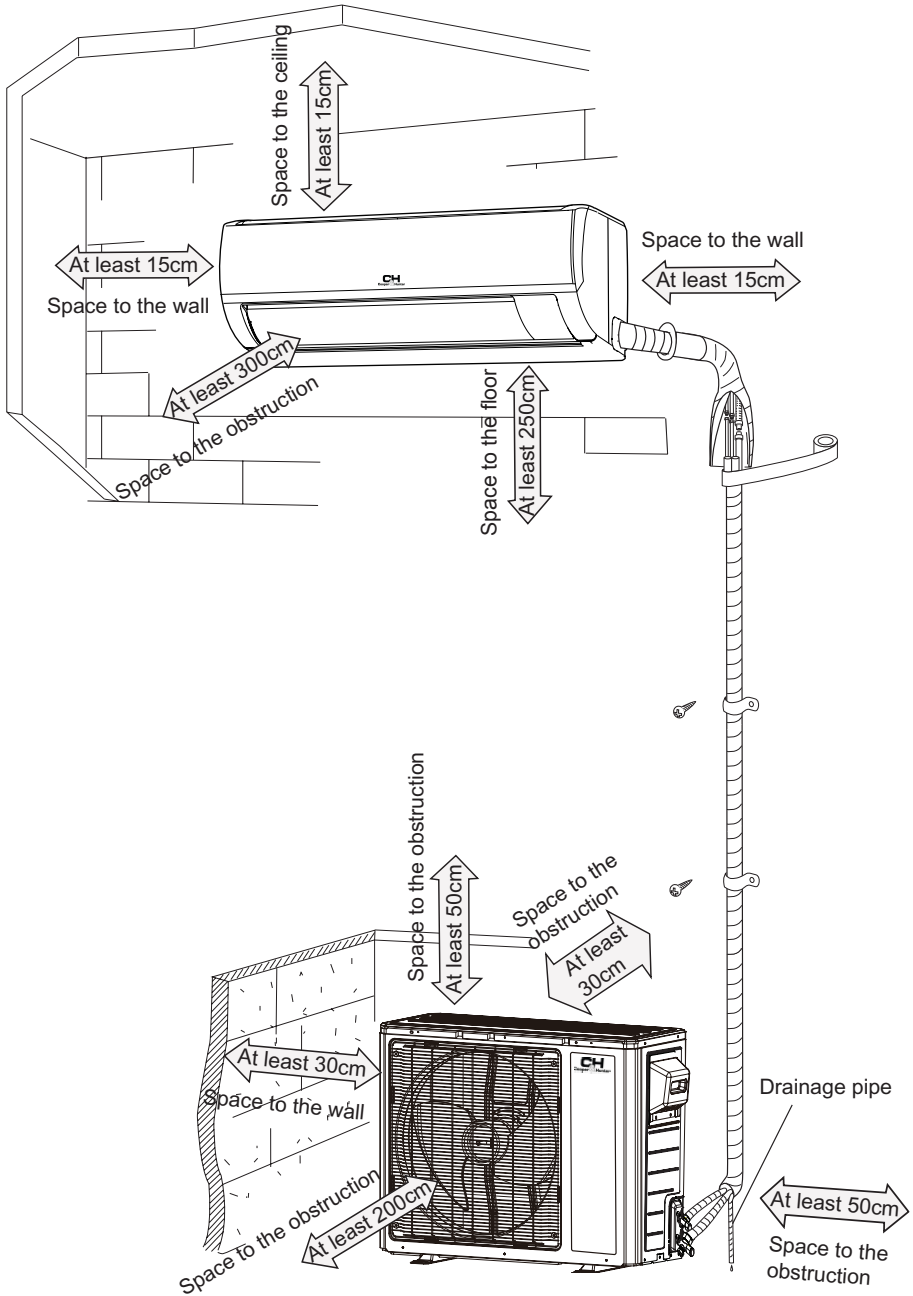



## Tools for installation

|                          |                   |                    |
|--------------------------|-------------------|--------------------|
| 1 Level meter            | 2 Screw driver    | 3 Impact drill     |
| 4 Drill head             | 5 Pipe expander   | 6 Torque wrench    |
| 7 Open-end wrench        | 8 Pipe cutter     | 9 Leakage detector |
| 10 Vacuum pump           | 11 Pressure meter | 12 Universal meter |
| 13 Inner hexagon spanner | 14 Measuring tape |                    |

### Note:

- Please contact the local agent for installation.
- Don't use unqualified power cord.

## Selection of installation location

### Basic requirement

Installing the unit in the following places may cause malfunction. If it is unavoidable, please consult the local dealer:

1. The place with strong heat sources, vapors, flammable or explosive gas, or volatile objects spread in the air.
2. The place with high-frequency devices (such as welding machine, medical equipment).
3. The place near coast area.
4. The place with oil or fumes in the air.
5. The place with sulfured gas.
6. Other places with special circumstances.
7. Do not use the unit in the immediate surroundings of a laundry, a bath, a shower, or a swimming pool.

### Indoor unit

1. There should be no obstruction near air inlet and air outlet.
2. Select a location where the condensation water can be dispersed easily and won't affect other people.
3. Select a location which is convenient to connect the outdoor unit and near the power socket.
4. Select a location which is out of reach for children.
5. The location should be able to withstand the weight of indoor unit and won't increase noise and vibration.
6. The appliance must be installed 2.5m above floor.
7. Don't install the indoor unit right above the electric appliance.
8. Please try your best to keep away from fluorescent lamp.

### Outdoor unit

1. Select a location where the noise and outflow air emitted by the outdoor unit will not affect neighborhood.
2. The location should be well ventilated and dry, in which the outdoor unit won't be exposed directly to sunlight or strong wind.
3. The location should be able to withstand the weight of outdoor unit.
4. Make sure that the installation follows the requirement of installation dimension diagram.
5. Select a location which is out of reach for children and far away from animals or plants. If it is unavoidable, please add the fence for safety purpose.

# Requirements for electric connection

## Safety precaution

1. Must follow the electric safety regulations when installing the unit.
2. According to the local safety regulations, use qualified power supply circuit and air switch.
3. Make sure the power supply matches with the requirement of air conditioner.  
Unstable power supply or incorrect wiring or malfunction. Please install proper power supply cables before using the air conditioner.
4. Properly connect the live wire, neutral wire and grounding wire of power socket.
5. Be sure to cut off the power supply before proceeding any work related to electricity and safety.
6. Do not put through the power before finishing installation.
7. If the supply cord is damaged, it must be replaced by the manufacturer, its service agent or similarly qualified persons in order to avoid a hazard.
8. The temperature of refrigerant circuit will be high, please keep the interconnection cable away from the copper tube.
9. The appliance shall be installed in accordance with national wiring regulations.

## Grounding requirement

1. The air conditioner is the first class electric appliance. It must be properly grounding with specialized grounding device by a professional. Please make sure it is always grounded effectively, otherwise it may cause electric shock.
2. The yellow-green wire in air conditioner is grounding wire, which can't be used for other purposes.
3. The grounding resistance should comply with national electric safety regulations.
4. The appliance must be positioned so that the plug is accessible.
5. An all-pole disconnection switch having a contact separation of at least 3mm in all poles should be connected in fixed wiring.
6. Including an air switch with suitable capacity, please note the following table. Air switch should be included magnet buckle and heating buckle function, it can protect the circuit-short and overload. (Caution: please do not use the fuse only for protect the circuit)

| Air-conditioner | Air switch capacity |
|-----------------|---------------------|
| 09、12K          | 16A                 |
| 18、24K          | 25A                 |

# Installation of indoor unit

## Step one: choosing installation location

Recommend the installation location to the client and then confirm it with the client.

## Step two: install wall-mounting frame

1. Hang the wall-mounting frame on the wall; adjust it in horizontal position with the level meter and then point out the screw fixing holes on the wall.
2. Drill the screw fixing holes on the wall with impact drill (the specification of drill head should be the same as the plastic expansion particle) and then fill the plastic expansion particles in the holes.
3. Fix the wall-mounting frame on the wall with tapping screws (ST4.2X25TA) and then check if the frame is firmly installed by pulling the frame. If the plastic expansion particle is loose, please drill another fixing hole nearby.

## Step three: open piping hole

1. Choose the position of piping hole according to the direction of outlet pipe. The position of piping hole should be a little lower than the wall-mounted frame, shown as below.

09、12K:

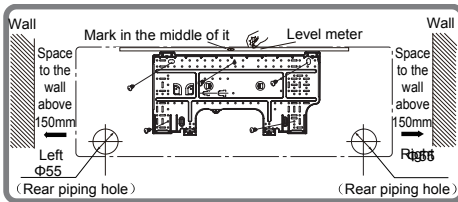

18K:

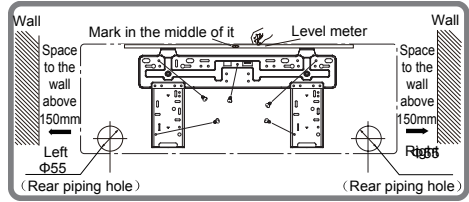

24K:

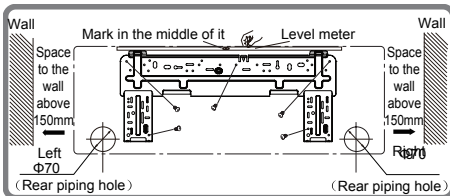

2. Open a piping hole with the diameter of  $\Phi 55/70$  on the selected outlet pipe position. In order to drain smoothly, slant the piping hole on the wall slightly downward to the outdoor side with the gradient of  $5-10^\circ$ .

# Installation of indoor unit

## Note:

- Pay attention to dust prevention and take relevant safety measures when opening the hole.
- The plastic expansion particles are not provided and should be bought locally.

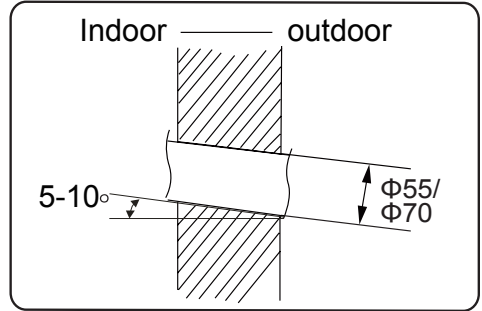

## Step four: outlet pipe

1. The pipe can be led out in the direction of right, rear right, left or rear left.

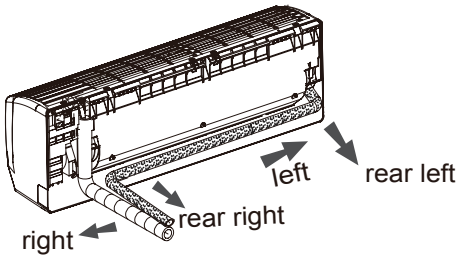

2. When select leading out the pipe from left or right, please cut off the corresponding hole on the bottom case.

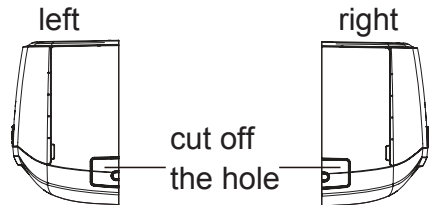

## Step five: connect the pipe of indoor unit

1. Aim the pipe joint at the corresponding bellmouth.
2. Pretightening the union nut with hand.

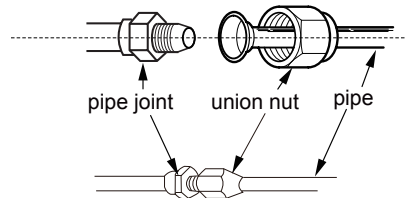

3. Adjust the torque force by referring to the following sheet. Place the open-end wrench on the pipe joint and place the torque wrench on the union nut. Tighten the union nut with torque wrench.

# Installation of indoor unit

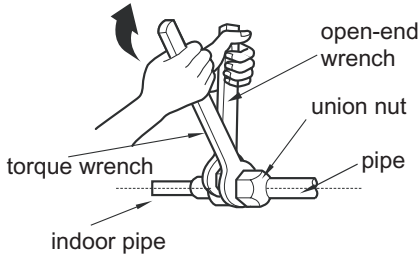

| Hex nut diameter | Tightening torque (N·m) |
|------------------|-------------------------|
| Φ 6              | 15~20                   |
| Φ 9.52           | 30~40                   |
| Φ 12             | 45~55                   |
| Φ 16             | 60~65                   |
| Φ 19             | 70~75                   |

4. Wrap the indoor pipe and joint of connection pipe with insulating pipe, and then wrap it with tape.

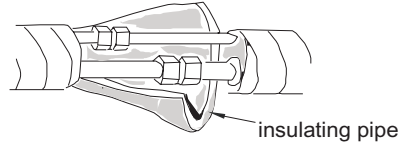

## Step six: install drain hose

1. Connect the drain hose to the outlet pipe of indoor unit.

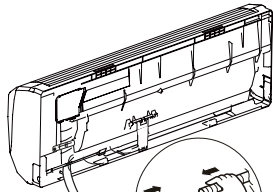

2. Bind the joint with tape.

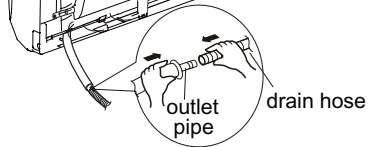
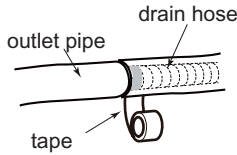

### Note:

- Add insulating pipe in the indoor drain hose in order to prevent condensation.
- The plastic expansion particles are not provided.

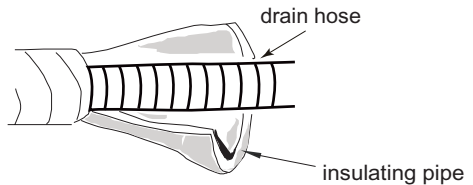

## Step seven: connect wire of indoor unit

1. Open the panel, remove the screw on the wiring cover and then take down the cover.

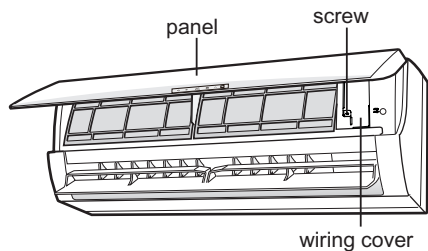

# Installation of indoor unit

2. Make the power connection wire go through the cable-cross hole at the back of indoor unit and then pull it out from the front side.

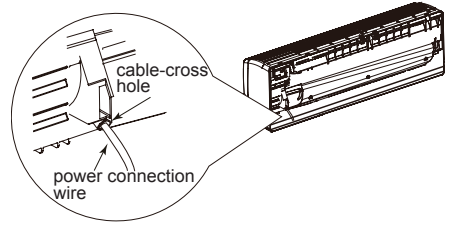

3. Remove the wire clip; connect the power connection wire to the wiring terminal according to the color; tighten the screw and then fix the power connection wire with wire clip.

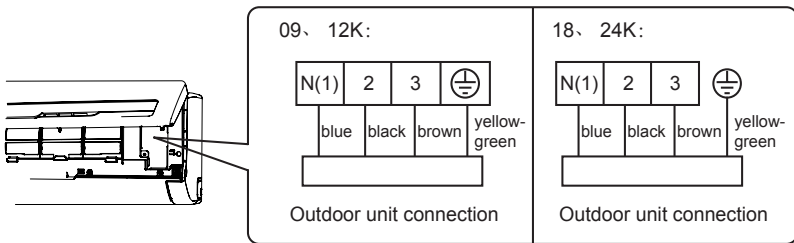

4. Put wiring cover back and then tighten the screw.
5. Close the panel.

## Note:

- All wires of indoor unit and outdoor unit should be connected by a professional.
- If the length of power connection wire is insufficient, please contact the supplier for a new one. Avoid extending the wire by yourself.
- For the air conditioner with plug, the plug should be reachable after finishing installation.
- For the air conditioner without plug, an circuit break must be installed in the line. The circuit break should be all-pole parting and the contact parting distance should be more than 3mm.

# Installation of indoor unit

## Step eight: bind up pipe

1. Bind up the connection pipe, power cord and drain hose with the band.

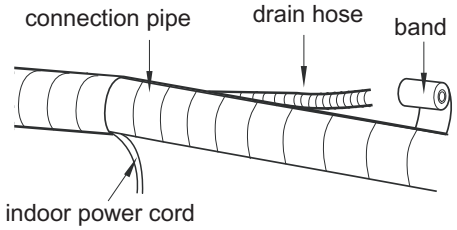
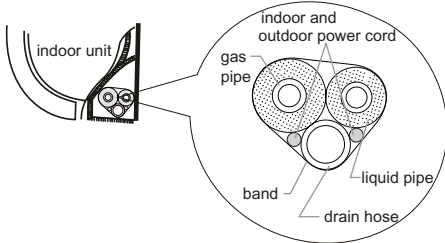

2. Reserve a certain length of drain hose and power cord for installation when binding them. When binding to a certain degree, separate the indoor power and then separate the drain hose.

3. Bind them evenly.
4. The liquid pipe and gas pipe should be bound separately at the end.

### Note:

- The power cord and control wire can't be crossed or winding.
- The drain hose should be bound at the bottom.

## Step nine: hang the indoor unit

1. Put the bound pipes in the wall pipe and then make them pass through the wall hole.
2. Hang the indoor unit on the wall-mounting frame.
3. Stuff the gap between pipes and wall hole with sealing gum.
4. Fix the wall pipe.
5. Check if the indoor unit is installed firmly and closed to the wall.

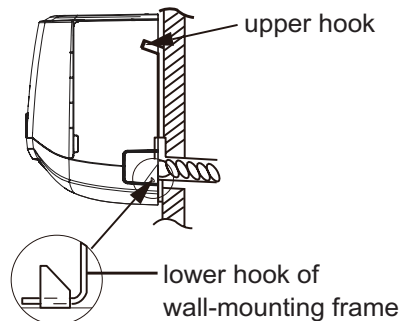
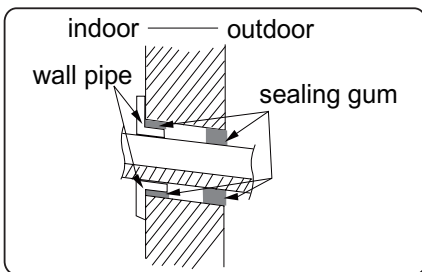

### Note:

- Do not bend the drain hose too excessively in order to prevent blocking.

# Installation of outdoor unit

## Step one: fix the support of outdoor unit

(select it according to the actual installation situation)

1. Select installation location according to the house structure.
2. Fix the support of outdoor unit on the selected location with expansion screws.

### Note:

- Take sufficient protective measures when installing the outdoor unit.
- Make sure the support can withstand at least four times of the unit weight.
- The outdoor unit should be installed at least 3cm above the floor in order to install drain joint.
- For the unit with cooling capacity of 2300W ~5000W, 6 expansion screws are needed; for the unit with cooling capacity of 6000W ~8000W, 8 expansion screws are needed; for the unit with cooling capacity of 10000W ~16000W, 10 expansion screws are needed.

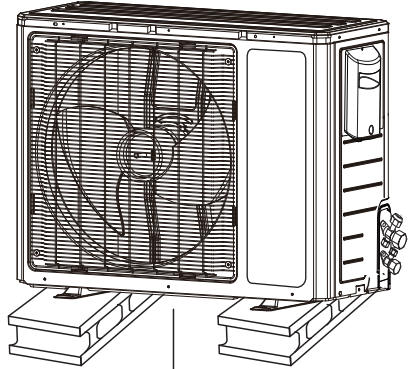

at least 3cm above the floor

## Step two: install drain joint (Only for cooling and heating unit)

1. Connect the outdoor drain joint into the hole on the chassis, as shown in the picture below.
2. Connect the drain hose into the drain vent.

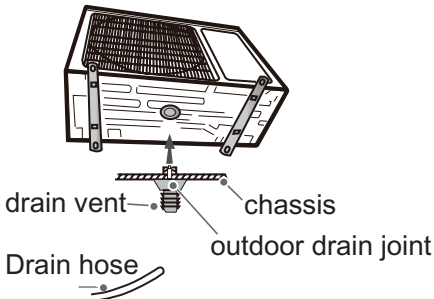

## Step three: fix outdoor unit

1. Place the outdoor unit on the support.
2. Fix the foot holes of outdoor unit with bolts.

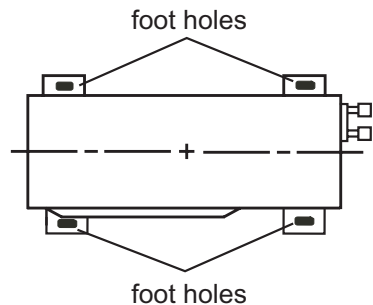



# Installation of outdoor unit

## Step four: connect indoor and outdoor pipes

1. Remove the screw on the right handle of outdoor unit and then remove the handle.



2. Remove the screw cap of valve and aim the pipe joint at the bellmouth of pipe.

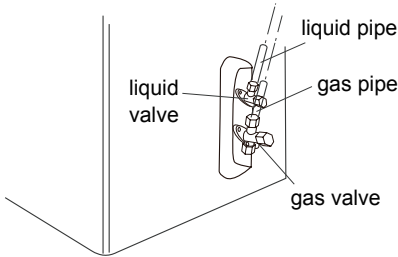

3. Pretightening the union nut with hand.

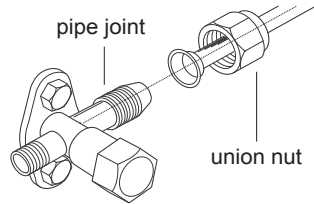

4. Tighten the union nut with torque wrench by referring to the sheet below.

| Hex nut diameter | Tightening torque (N·m) |
|------------------|-------------------------|
| Φ 6              | 15~20                   |
| Φ 9.52           | 30~40                   |
| Φ 12             | 45~55                   |
| Φ 16             | 60~65                   |
| Φ 19             | 70~75                   |

## Step five: connect outdoor electric wire

1. Remove the wire clip; connect the power connection wire and signal control wire (only for cooling and heating unit) to the wiring terminal according to the color; fix them with screws.

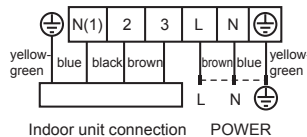
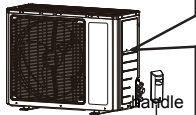

Note: the wiring board is for reference only, please refer to the actual one.

# Installation of outdoor unit

2. Fix the power connection wire and signal control wire with wire clip (only for cooling and heating unit).

## Note:

- After tighten the screw, pull the power cord slightly to check if it is firm.
- Never cut the power connection wire to prolong or shorten the distance.

## Step six: neaten the pipes

1. The pipes should be placed along the wall, bent reasonably and hidden possibly. Min. semidiameter of bending the pipe is 10cm.
2. If the outdoor unit is higher than the wall hole, you must set a U-shaped curve in the pipe before pipe goes into the room, in order to prevent rain from getting into the room.

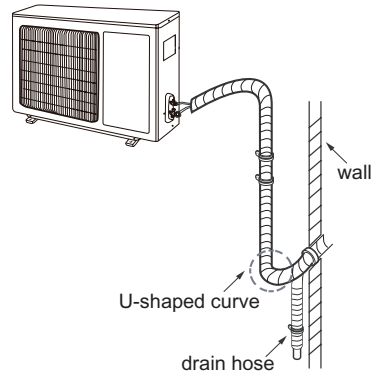

## Note:

- The through-wall height of drain hose shouldn't be higher than the outlet pipe hole of indoor unit.
- Slant the drain hose slightly downwards. The drain hose can't be curved, raised and fluctuant, etc.

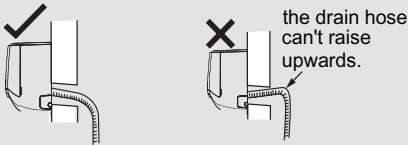

- The water outlet can't be placed in water in order to drain smoothly.

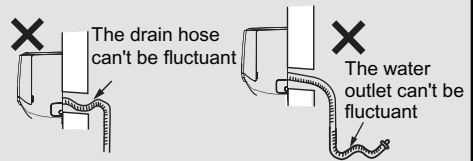
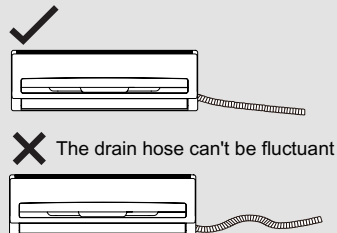
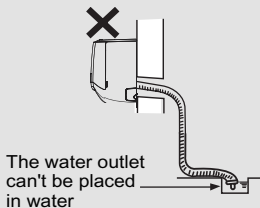

# Vacuum pumping

## Use vacuum pump

1. Remove the valve caps on the liquid valve and gas valve and the nut of refrigerant charging vent.
2. Connect the charging hose of piezometer to the refrigerant charging vent of gas valve and then connect the other charging hose to the vacuum pump.
3. Open the piezometer completely and operate for 10-15min to check if the pressure of piezometer remains in  $-0.1\text{MPa}$ .
4. Close the vacuum pump and maintain this status for 1-2min to check if the pressure of piezometer remains in  $-0.1\text{MPa}$ . If the pressure decreases, there may be leakage.
5. Remove the piezometer, open the valve core of liquid valve and gas valve completely with inner hexagon spanner.
6. Tighten the screw caps of valves and refrigerant charging vent.
7. Reinstall the handle.

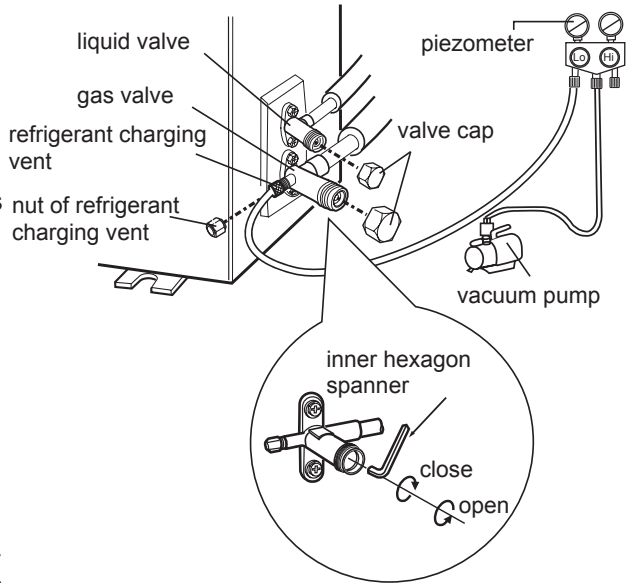

## Leakage detection

1. With leakage detector:  
Check if there is leakage with leakage detector.
2. With soap water:  
If leakage detector is not available, please use soap water for leakage detection. Apply soap water at the suspected position and keep the soap water for more than 3min. If there are air bubbles coming out of this position, there's a leakage.

## Check after installation

- Check according to the following requirement after finishing installation.

| Items to be checked  | Possible malfunction                                  |
|--|---|
| Has the unit been installed firmly?  | The unit may drop, shake or emit noise.               |
| Have you done the refrigerant leakage test?                                      | It may cause insufficient cooling (heating) capacity. |
| Is heat insulation of pipeline sufficient?                                       | It may cause condensation and water dripping.         |
| Is water drained well?   | It may cause condensation and water dripping.         |
| Is the voltage of power supply according to the voltage marked on the nameplate? | It may cause malfunction or damaging the parts.       |
| Is electric wiring and pipeline installed correctly?                             | It may cause malfunction or damaging the parts.       |
| Is the unit grounded securely?   | It may cause electric leakage.                        |
| Does the power cord follow the specification?                                    | It may cause malfunction or damaging the parts.       |
| Is there any obstruction in the air inlet and outlet?                            | It may cause insufficient cooling (heating) capacity. |
| The dust and sundries caused during installation are removed?                    | It may cause malfunction or damaging the parts.       |
| The gas valve and liquid valve of connection pipe are open completely?           | It may cause insufficient cooling (heating) capacity. |

## Test operation

### 1. Preparation of test operation

- The client approves the air conditioner.
- Specify the important notes for air conditioner to the client.

### 2. Method of test operation

- Put through the power, press ON/OFF button on the remote controller to start operation.
- Press MODE button to select AUTO, COOL, DRY, FAN and HEAT to check whether the operation is normal or not.
- If the ambient temperature is lower than 16°C , the air conditioner can't start cooling.

# Configuration of connection pipe

1. Standard length of connection pipe
  - 5m, 7.5m, 8m.
2. Min. length of connection pipe is 3m.
3. Max. length of connection pipe and max. high difference.

| Cooling capacity   | Max length of connection pipe | Max height difference | Cooling capacity    | Max length of connection pipe | Max height difference |
|--------------------|-------------------------------|-----------------------|---------------------|-------------------------------|-----------------------|
| 5000Btu/h (1465W)  | 15                            | 5                     | 24000Btu/h (7032W)  | 25                            | 10                    |
| 7000Btu/h (2051W)  | 15                            | 5                     | 28000Btu/h (8204W)  | 30                            | 10                    |
| 9000Btu/h (2637W)  | 15                            | 5                     | 36000Btu/h (10548W) | 30                            | 20                    |
| 12000Btu/h (3516W) | 20                            | 10                    | 42000Btu/h (12306W) | 30                            | 20                    |
| 18000Btu/h (5274W) | 25                            | 10                    | 48000Btu/h (14064W) | 30                            | 20                    |

4. The additional refrigerant oil and refrigerant charging required after prolonging connection pipe
  - After the length of connection pipe is prolonged for 10m at the basis of standard length, you should add 5ml of refrigerant oil for each additional 5m of connection pipe.
  - The calculation method of additional refrigerant charging amount (on the basis of liquid pipe):
 

Additional refrigerant charging amount = prolonged length of liquid pipe × additional refrigerant charging amount per meter
  - When the length of connection pipe is above 5m, add refrigerant according to the prolonged length of liquid pipe. The additional refrigerant charging amount per meter is different according to the diameter of liquid pipe. See the following sheet.

# Configuration of connection pipe

Additional refrigerant charging amount for R22, R407C, R410A and R134a

| Diameter of connection pipe |                | Outdoor unit throttle |                          |
|-----------------------------|----------------|-----------------------|--------------------------|
| Liquid pipe(mm)             | Gas pipe(mm)   | Cooling only(g/m)     | Cooling and heating(g/m) |
| Φ6                          | Φ9.52 or Φ12   | 15                    | 20                       |
| Φ6 or Φ9.52                 | Φ16 or Φ19     | 15                    | 50                       |
| Φ12                         | Φ19 or Φ22.2   | 30                    | 120                      |
| Φ16                         | Φ25.4 or Φ31.8 | 60                    | 120                      |
| Φ19                         | —              | 250                   | 250                      |
| Φ22.2                       | —              | 350                   | 350                      |

# Pipe expanding method

## Note:

Improper pipe expanding is the main cause of refrigerant leakage. Please expand the pipe according to the following steps:

### A: Cut the pipe

- Confirm the pipe length according to the distance of indoor unit and outdoor unit.
- Cut the required pipe with pipe cutter.

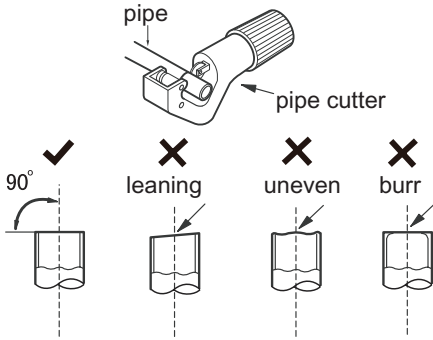

### B: Remove the burrs

- Remove the burrs with shaper and prevent the burrs from getting into the pipe.

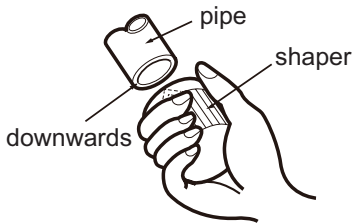

### C: Put on suitable insulating pipe

### D: Put on the union nut

- Remove the union nut on the indoor connection pipe and outdoor valve; install the union nut on the pipe.

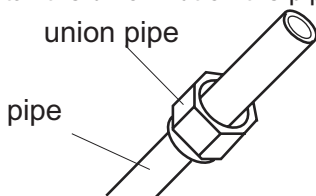

### E: Expand the port

- Expand the port with expander.

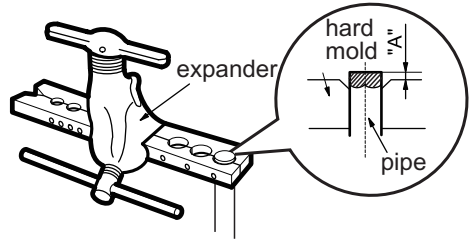

### Note:

- "A" is different according to the diameter, please refer to the sheet below:

| Outer diameter (mm) | A(mm) |     |
|---------------------|-------|-----|
|                     | Max   | Min |
| Φ6 - 6.35(1/4")     | 1.3   | 0.7 |
| Φ9.52(3/8")         | 1.6   | 1.0 |
| Φ12-12.7(1/2")      | 1.8   | 1.0 |
| Φ15.8-16(5/8")      | 2.4   | 2.2 |

### F: Inspection

- Check the quality of expanding port. If there is any blemish, expand the port again according to the steps above.

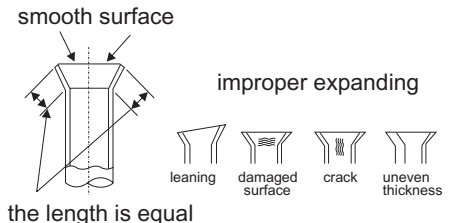

the length is equal

**Designed by Cooper&Hunter International Corporation, Oregon, USA**  
**[www.cooperandhunter.com](http://www.cooperandhunter.com)**  
**E-mail: [info@cooperandhunter.com](mailto:info@cooperandhunter.com)**

\* Cooper & Hunter is constantly working to improve their products, so the information in this manual is subject to change without prior notice.



6616000078