

EN

USER'S MANUAL



ENERGY RECOVERY VENTILATION SYSTEM



MODELS:

CH-HRV2K2

CH-HRV3K2

CH-HRV4K2

CH-HRV6K2

CH-HRV8K2

CH-HRV10K2

CH-HRV13K2



Attention

For proper operation, please read and keep this manual carefully
Designed by Cooper&Hunter International Corporation, Oregon, USA

www.cooperandhunter.com





Contents



















Safety Considerations-----	3,4
Unit Specifications-----	5
Dimensioned Drawings-----	6
Installation Considerations-----	7,8
Electrical Installation-----	9
Wiring Diagrams-----	10
Commissioning Information-----	11
Controller Instruction-----	12 to 15
Dial switch-----	16
Maintenance -----	17

Safety Considerations

Please read the following safety instructions before installation. And ensure that the unit is installed correctly.







Please observe all instruction in order to avoid any injury or damage to equipment or property.

Safety attentions			
The following symbols indicate potential levels of caution.			
 Warning	Situations with a risk or death or serious injure.	 Attention	Situations with a risk of injury or equipment/property damage.
The following symbols indicate compliance which must be observed			
	Not allowed or Stop		Must follow  or obliged

 Warning			
	Installation to be carried out by qualified person, End Users must not install, move or re-install this equipment by themselves		An anti-bird net or similar device should be installed to outside vents. Ensure there are no obstructions to or in the ducts
	Installation engineers must follow this manual strictly. Improper action can create a health hazard and reduce efficiency of the unit		Fresh air vent must be far enough away from any flue gas discharge or areas where hazardous vapors are present
	Unit must be installed strictly following this manual and mounted to a weight bearing surface for the weight of the unit		Electric engineering must follow national regulations and the manual, use special cables. Less capacity cables and improper engineering can cause electric shock or fire.
	During maintenance or repair, the unit and circuit breaker must be switched off. Otherwise electric shock could occur.		Ground wire cannot be connected to gas pipe, water pipe, lighting rod or telephone line etc. Incorrect grounding can cause electric shock.
 Attention			
	Power cable and wires must be installed by a qualified electrical engineer. Improper connection can cause over heating. Fire and loss of efficiency.		To avoid condensation, insulation should be fitted to fresh air ducts. Other ducting may also require insulation depending on dew point conditions.
	Insulation between the metal ducting and wall penetration must be installed if the ducting penetrates metal wall cladding, to avoid risk of electric shock or current leakage.		The cover of wiring box must be pressed down and closed to avoid dust and dirt entering. Excess dust and dirt can cause overheating of terminals and result in fire or electric shock.
	Use only approved installation hardware and accessories. Failure to observe can result in fire risk, electric shock and equipment failure		Where the unit is positioned, at high level in a hot humid situation. Please ensure sufficient ventilation is available
	The outdoor ducts must be installed facing downwards to avoid rain water entering. Improper installation can cause water leakage.		Correctly sized MCB must be fitted to the unit suitable earth leakage protection should also be installed to avoid risk of electric shock or fire.

Safety Considerations

Safety Considerations

 Attention			
	Do not install the unit in an extremely humid conditions, as it may result in electric shock and pose a fire risk.		Do not use the units as the primary kitchen extract grease and fatty deposits can block the heat exchanger, filter and pose a fire risk.
	Don not install the unit in areas there any poisonous or caustic gases are present.		Do not install the unit near open flame as it may result in over heating and pose a fire risk
	Acidic or alkali environments can cause poisoning or a fire		Rated supply voltage must be maintained, otherwise this may cause fire.

Specifications

Model		CH-HRV2K2	CH-HRV3K2	CH-HRV4K2	CH-HRV6K2	CH-HRV8K2	CH-HRV10K2	CH-HRV13K2	
Airflow	(m3/h)	L	150	250	350	500	700	900	1000
		M	200	300	400	600	800	1000	1300
		H	200	300	400	600	800	1000	1300
External pressure	(Pa)	L	60	75	80	89	92	80	75
		M	70	82	85	92	96	85	85
		H	75	85	88	97	100	86	90
Enthalpy Eff.(%)	Cooling	L	60	62	62	63	57	60	58
		M	55	57	57	59	55	58	56
		H	55	57	57	59	55	58	56
	Heating	L	63	65	65	67	63	64	62
		M	59	61	60	61	57	62	59
		H	59	61	60	61	57	62	59
Temp.Eff.	%	L	75	73	74	76	74	76	76
		M	70	68	69	70	68	70	70
		H	70	68	69	70	68	70	70
Noise	dB(A)	L	22	23	25	25	32	32	37
		M	25	27	29	31	37	36	40
		H	27	30	32	35	39	40	42
Voltage (V)		220	220	220	220	220	220	220	
Current (A)		0.5	0.56	0.72	0.96	1.7	2.1	3.4	
Input Power (W)		105	117	150	200	355	440	710	
Net Weight (KG)		23	25	31	36	60	70	79	

Dimensioned Drawings

CH-HRV2K2 to HRV13K2 Models

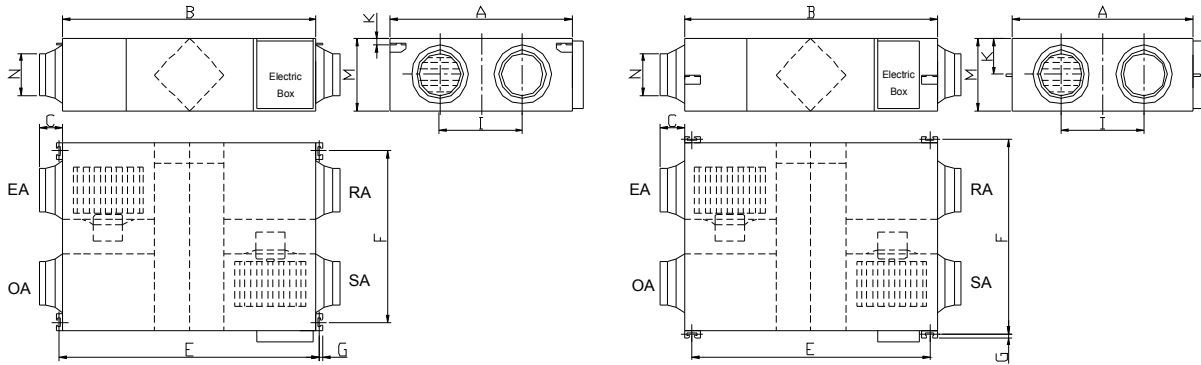

Model	A	B	C	E	F	G	I	K	M	N
CH-HRV2K2	580	666	100	725	510	19	290	20	264	φ144
CH-HRV3K2	599	744	100	675	657	19	315	111	270	Φ144
CH-HRV4K2	804	744	100	675	862	19	480	111	270	Φ144
CH-HRV6K2	904	824	107	754	960	19	500	111	270	φ194
CH-HRV8K2	884	1116	85	1045	940	19	428	170	388	φ242
CH-HRV10K2	1134	1116	85	1045	1190	19	678	170	388	φ242
CH-HRV13K2	1134	1116	85	1045	1190	19	678	170	388	φ242

Installation Considerations

Protect the unit to avoid dust or other obstructions entering the unit and accessories during installation, or whilst in storage on site. Service ports should be installed to allow access for filter maintenance.

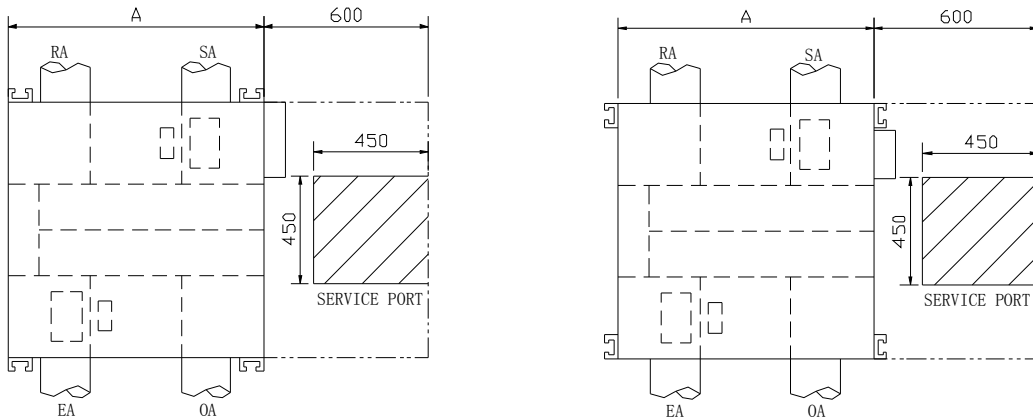

Model	A	Inner ceiling height B
CH-HRV2K2	580	320

Model	A	Inner ceiling height B
CH-HRV3K2	599	320
CH-HRV4K2	804	320
CH-HRV6K2	904	320
CH-HRV8K2	884	450
CH-HRV10K2	1134	450
CH-HRV13K2	1134	450

Installation Considerations

Installation Diagram

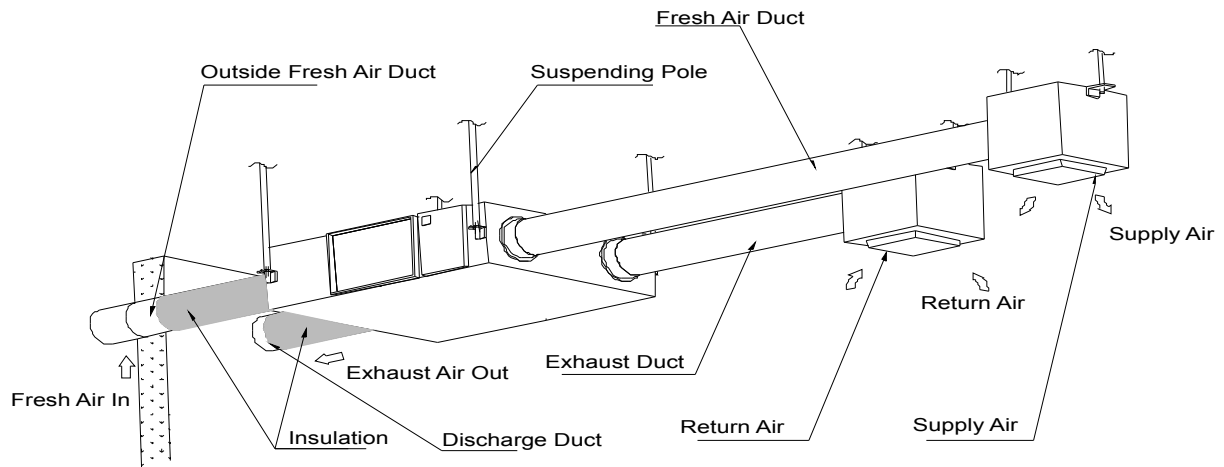

Physical Installation

1. Installer to prepare suitable threaded hangers with adjustable nuts and gaskets.
2. Install as shown by the image above. Installation must be level and securely fastened.
3. Failure to observe proper fixing could result in injury, equipment damage and excessive vibration. Uneven installation will also effect damper operation.

Notes for reverse installation of the unit

4. Reverse labeling shows the unit is upside down.

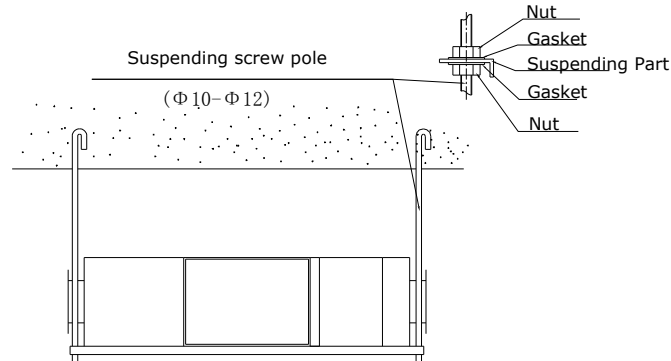

Ducting

1. Connection of unit vents and ducts should be taped or sealed to prevent air leakage, and should comply to relevant guidelines and regulations.
2. The two outdoor vents should face downward toward the outside to prevent any rain water ingress. (angle 1/100 1/50).
3. Insulation must be with the two ducts outside to prevent condensation.

Material: glass cotton, Thickness: 25mm

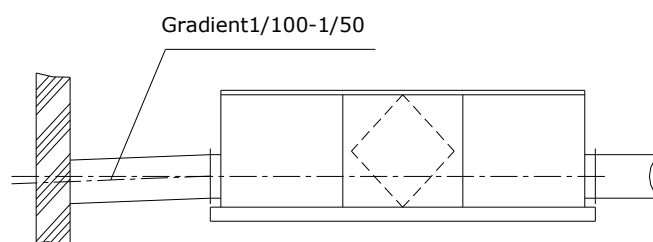

Installation Considerations

1. Be sure the ceiling height is no less than the Figures in above table B column.
2. Unit must not be installed close to boiler flues.
3. Following phenomenon should be avoided in the ducting installation.

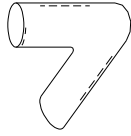

Severe bends

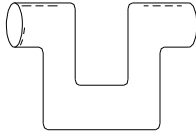

Multiple direction changes

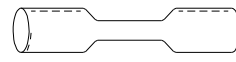

Multiple reducers/ crimped duct

4. Excessive use of flex-duct and long flex-duct runs should be avoided.
5. Fire dampers must be fitted as per national and local fire regulations.
6. Unit must not be exposed to ambient temperature above 40°C and should not face an open fire.
7. Take action to avoid dew and frost.

As shown by drawing below, unit will produce dew or frost when saturation curve is formed from A to C. Use pre-heater to ensure conditions are kept to right of the curve (B to B' , to move C to C') to prevent condensation or frost formation.

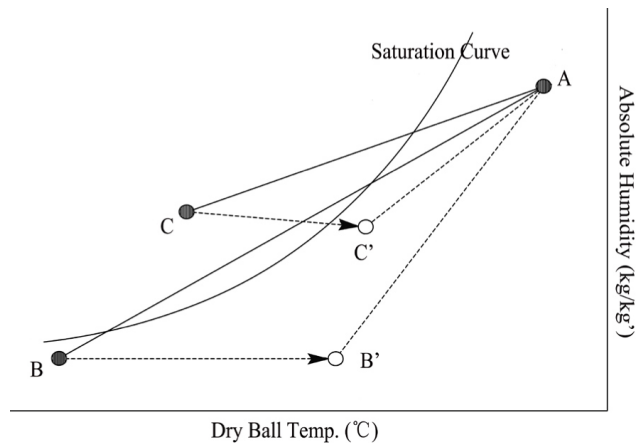

8. To avoid the outdoor exhaust air cycling back to indoor, the distance between the two vents installed on the outside wall should be over 1000mm.
9. If heater is equipped to the unit, operation of heater should be synchronous with the unit, so that the heater starts to work only when unit starts.
10. Duct muffler may be considered if user wants indoor noise to be minimized.

Electrical Installation

Warning

Power must be isolated during installation and before maintenance to avoid injury by electric shock. The specifications of cables must strictly match the requirements, otherwise it may cause performance failure and danger of electric shock or fire.

Power supply is AC220V/50HZ/1 Phase. Open the cover of electrical box, connect the 2 wires (L/N/) to the terminals and connect the cable of the control panel to the board according to the wiring diagram, and join the control panel to the cable.

Model	Spec. of power supply cable	Spec. of normal controller cable
CH-HRV2K2	3×1.5mm ²	7×0.75~1mm ²
CH-HRV3K2		
CH-HRV4K2		
CH-HRV6K2		
CH-HRV8K2		8×0.75~1mm ²
CH-HRV10K2		
CH-HRV13K2		

Warning

We do not accept any liability for any problems caused by the user's self and non-authorized re-engineering to the electrical and control systems.

Model	Capacitor		Power Supply	Control Panel Model
CH-HRV2K2, CH-HRV3K2	1.5μF	450V AC	220V/1Ph/50Hz	HDK-10 series
CH-HRV4K2	3μF	450V AC		
CH-HRV6K2	3.5μF	450V AC		
CH-HRV8K2	8μF	450V AC		
CH-HRV10K2	10μF	450V AC		
CH-HRV13K2	7μF	450V AC		





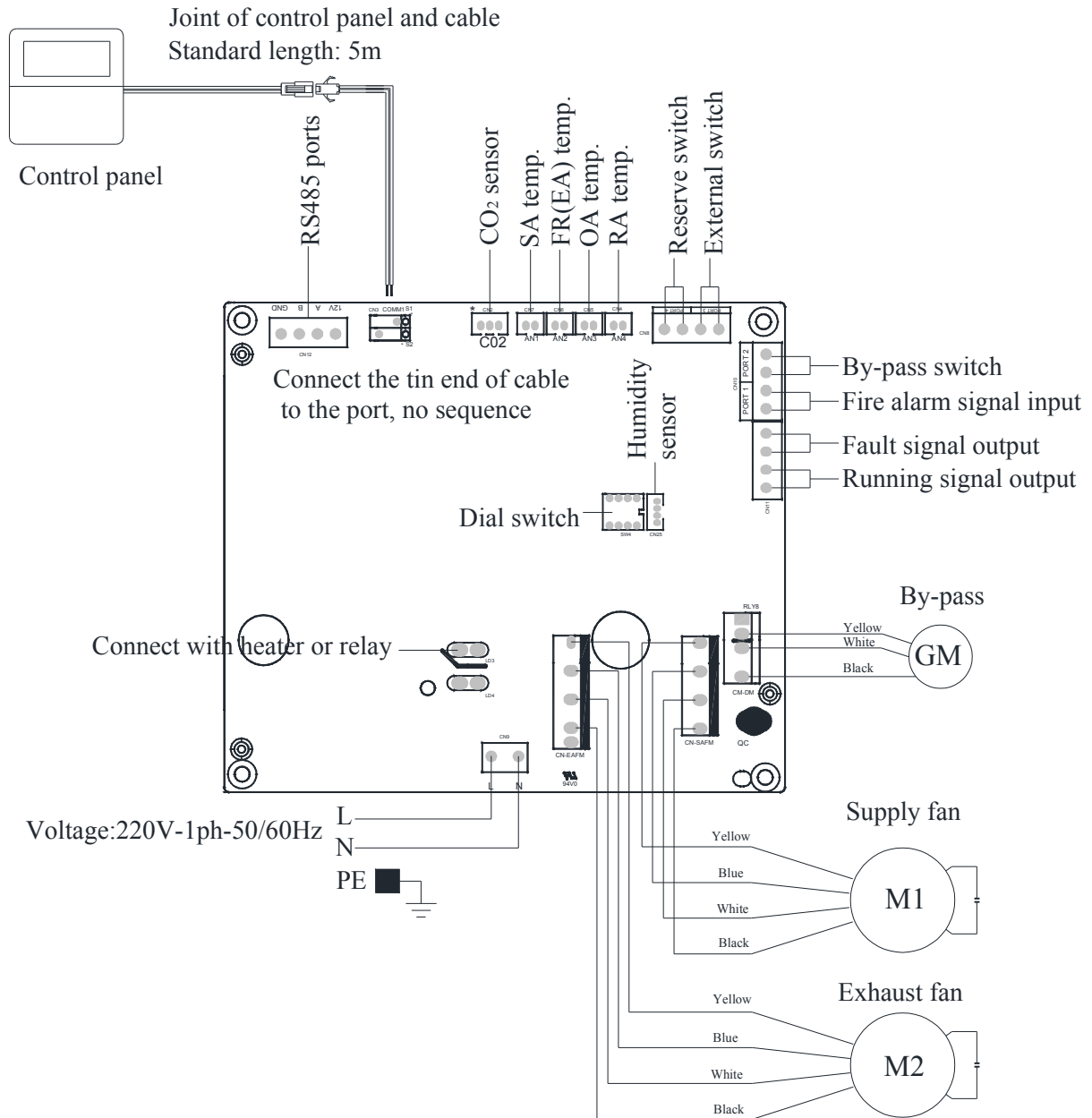







Wiring Diagrams













CH-HRV2K2 to HRV13K2



Commissioning

Check that all cable sizes, circuit breakers and wire connections are correct before following below commissioning steps:

1. Press the power button  once for starting; twice for closing. In On status, the light of power indicator is on, while in OFF status, the light is off.
2. Match the correct fan speeds displayed on LCD controller. Press button  for 6 seconds to enter parameter settings and at this time the parameter number is shown in the middle of the screen, press button  to switch to parameter No. 23 (refer to parameters list in coming page) then press  to enter the parameter setting, default value flash at the right corner, press UP and DWON buttons to change the value to be "1"(3 speeds control) then press button  again to confirm setting.
3. Then check the mode and fan speed switch. Press button  to switch *rR* , *oR* or *SR* mode, check whether the temperature of the corresponding mode is correct. Press  to switch the fan speed of *rR* and *SR* , check if the airflow is adjusted corresponding to high speed, medium speed or low speed.
4. Check the operation of bypass. The default opening temperature of bypass is 19-21C (adjustable), press button  to check the temperature of *oR* . If the *oR* is 19-21C, the bypass will open automatically. If the outdoor temperature is not within 19-21C, then adjust the bypass opening temperature according the current *oR* temperature to check the bypass function.
5. Bypass open temperature setting: press  more than 6 seconds to enter the parameter setting mode. Press  twice to switch the parameter number from 00 to 02, the value flashes shown at the right corner, the default value is 19. Then press  to modify the value according to the current *oR* temperature by pressing up-down button and press  to save the data. At the same time, check the bypass is opened or not. Please remember to modify the bypass opening temperature to 19-21 after the commissioning.

 Warning			
	Loose or incorrect wiring connection can cause explosion or fire when the unit starts to work. Use only rated power voltage.		Don't put fingers or objects into vents of fresh air or exhaust air supply. Injury may be caused by the rotation of the impeller.
	Don't install, move or re-install the unit by yourself. Improper action may cause unit instability, electric shock or fire.		Don't change, disassemble or repair the unit by yourself. Improper action may cause electric shock or fire.
	Running the unit continuously in an abnormal status may cause failure, electric shock or fire.		Switch off the power and breaker when you clean the exchanger.
 Attention			
	Don't site intake supply vent in hot and humid conditions , as it may cause failure, current leakage or fire.		Don't put any burner directly facing the fresh air discharge, otherwise it may cause an insufficient burning.
	Isolate power during extended off periods Isolate power and take care when cleaning unit. (Risk of electric shock)		Observe guidelines and regulations relating to incomplete combustion when use is associated with fuel burning appliances.
	Clean the filter regularly. A blocked filter may result in poor indoor air quality.		

Intelligent Controller Instruction

Control Panel

The intelligent controller is surface mounted and comes with a LCD display screen. The standard connection cable is 5 meters, but you can prepare extra cable if necessary.

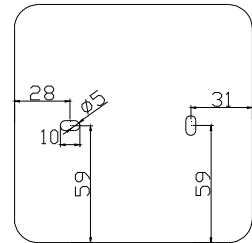
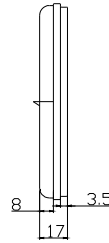
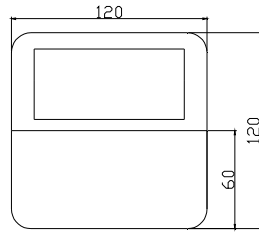

LCD display screen

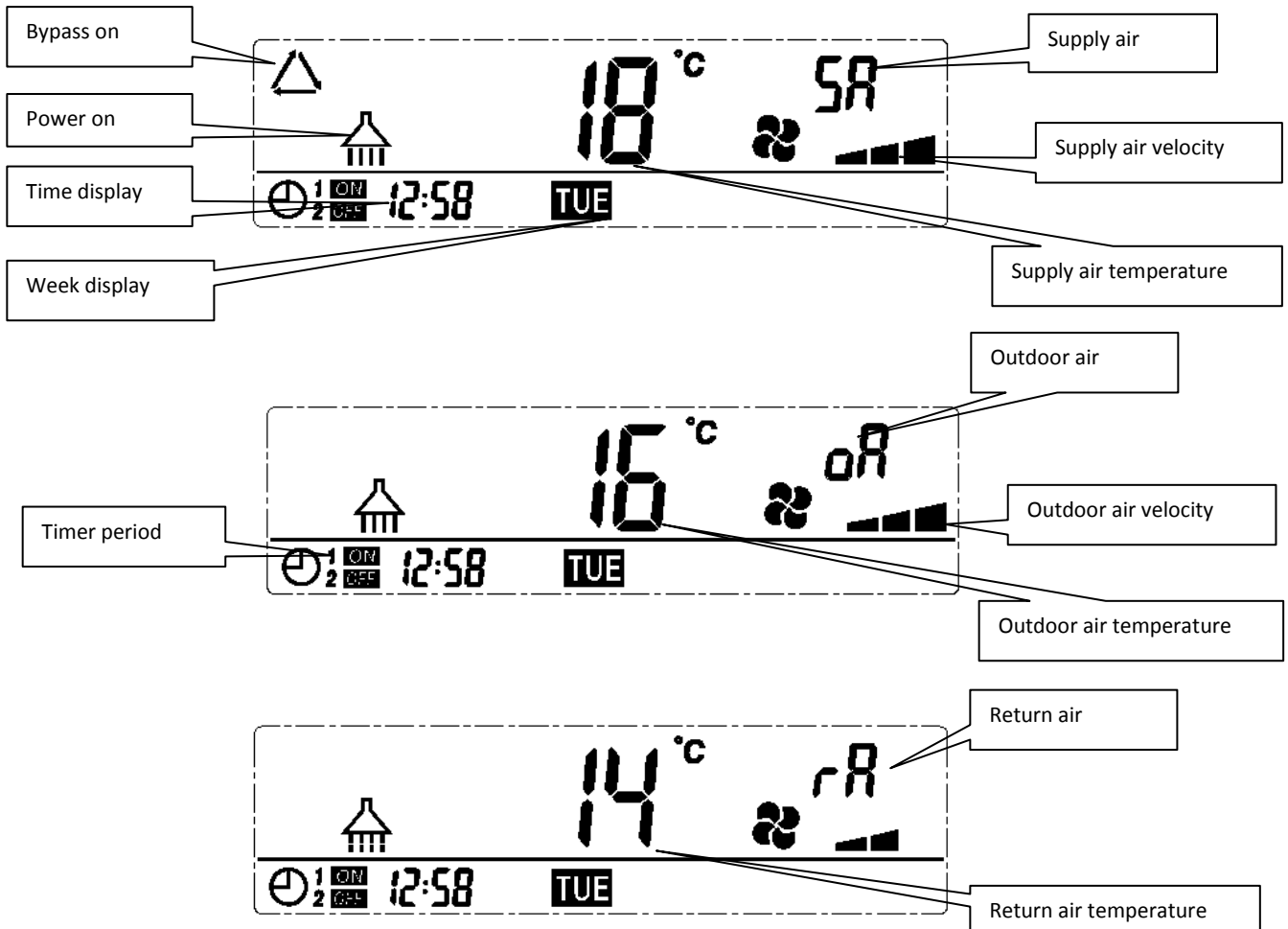
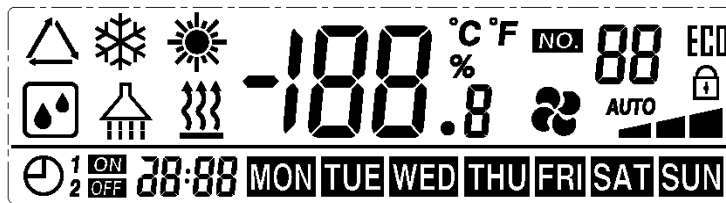

Intelligent Controller Instruction

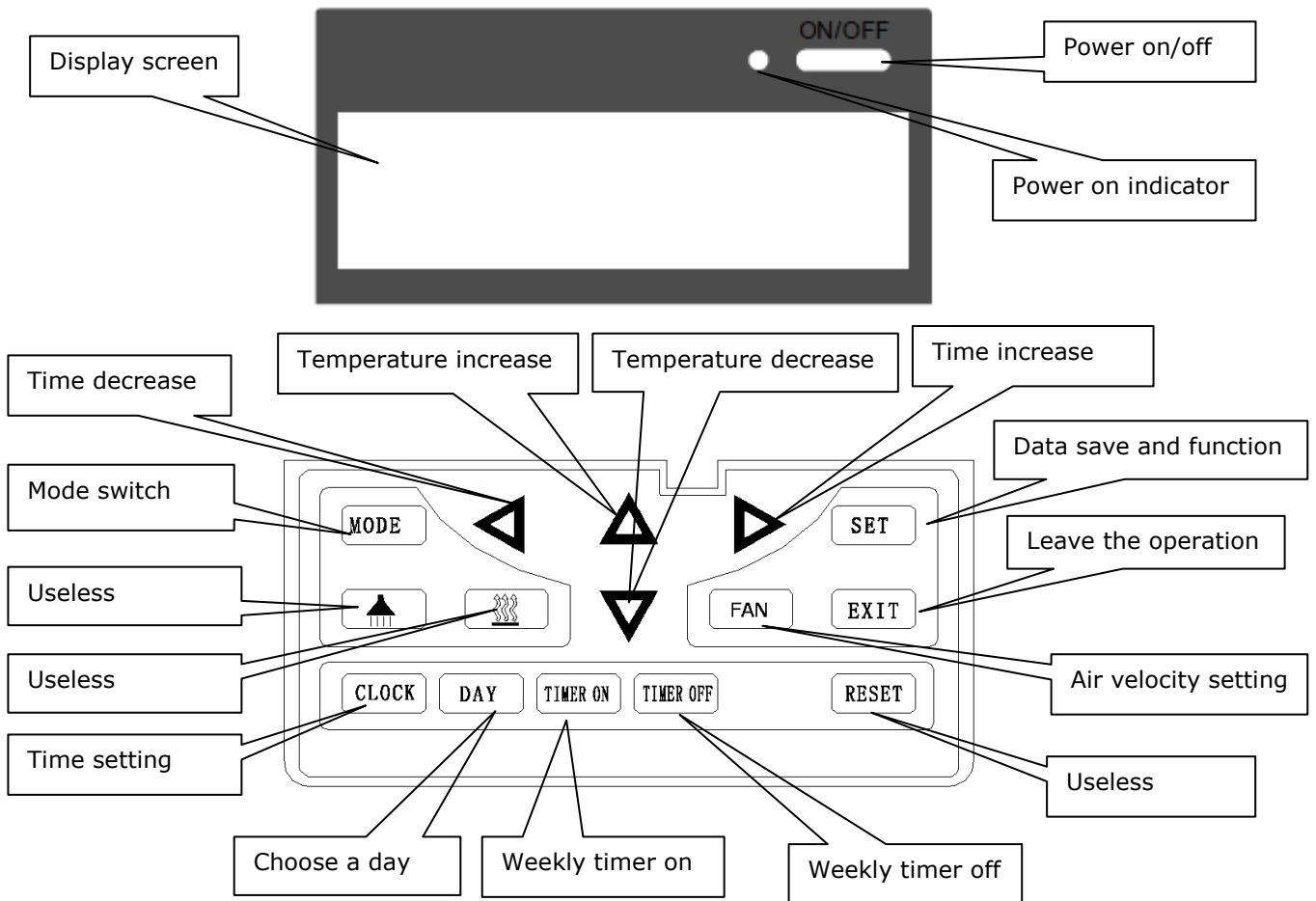

Operation Instructions

- ON/OFF:** press ON/OFF button once for starting; twice for closing. In ON status, the light of power indicator is on, and the ventilator begins to run. In OFF status, the light is off and the ventilator stops.
- Mode switch:** press MODE to choose to display the oA/rA/SA/Fr status.
- Air velocity setting:** press FAN button to adjust the air velocity. Users can set the return air velocity in "rA" status, and set the supply air velocity in "SA" status.
- Time setting:** time records if power off. If user need to reset the time, please press the CLOCK button, when the colon of the clock stills, press it again, then the hour flashes, users can press button◀▶ to adjust the hour; then press the CLOCK button again to adjust the minute in the same way, the interval is 10 minutes. After setting, please press SET button to save the data or press EXIT to leave the operation without saving the data. If no operation in 8 seconds, display will disappear and all setting is invalid.
- Day setting:** press DAY button, when the day code flashes, select the day by pressing button◀ and ▶. After setting, please press SET button to save the data or press EXIT to exit without saving the data. If no operation in 8 seconds, display will disappear and all setting is invalid.
- Weekly timer on:** press TIMER ON button, all the days display, then press this button to switch the hour->minute->invalidation of timer. Users can set the hour and minute when flashing. When it shows "--:--"; it means timer is invalid. Besides, users can press DAY button to switch the day, the day flashed when chosen. After setting, please press SET button to save the data or press EXIT to leave the operation without saving the data. In the status of TIMER ON, code "1" "2" stands for the first or second period of timer. User can choose the period of timer by pressing the button of "MODE". If no operation in 8 seconds, display will disappear and all setting is invalid.

Intelligent Controller Instruction

7. Weekly timer off: press TIMER OFF button, all the days display, then press this button to switch the hour->minute->invalidation of timer. Users can set the hour and minute when flashing. When it shows "--:--"; it means timer is invalid. Besides, users can press DAY button to switch the day, the day flashed when chosen.

After setting, please press SET button to save the data or press EXIT to leave the operation without saving the data. In the status of TIMER OFF, code "1" "2" stands for the first or second period of timer. User can choose the period of timer by pressing the button of "MODE". If no operation in 8 seconds, display will disappear and all setting is invalid.

8. Check weekly timer: press DAY button, and press button ◀ and ▶ to choose the day, then the set timer on and timer off will display. Users can press TIMER ON or TIMER OFF button to check the exact time.

9. The running of weekly timer: the control system will record the current time, the ventilator starts to run automatically when the timer is on, if the unit is on already, it maintains running. On the other hand, it stops when the timer is off, if it is off already, it remains stop status. The timer on and off can be used independently or simultaneously. When the timer is ON/OFF, users can still change the ON/OFF status of the unit.

10. Parameter List of Controller are kept after restarting from power-off.

No.	Contents	Range	Default	Unit	Record Position
00	Power to auto restart	0-1	1		Main control
01	Electrical heater available	0-1	0		Main control
02	Bypass opening temperature X	5-30	19	°C	Main control
03	Bypass opening temperature range Y	2-15	3	°C	Main control
04	Defrosting interval	15-99	30	Minute	Main control
05	Defrosting entering temperature	-9-5	- 1	°C	Main control
06	Defrosting duration time	2-20	10	Minute	Main control
07	CO2 sensor function value	28-C8 (392-1960PPM)	66 (1000PPM)	PPM	Main control
08	ModBus address	1-16	1		Main control
21	ERV models match/selection	0-7	0		Main control
23	Fan speed control	0: 2 speeds 1: 3 speeds 2: 10 speeds (DC)	1		
24	Multifunction setting	0: Reserved 1: Sweep filter alarm 2: sweep weekly timer	0		
25	Filter alarm setting	0: 45 days 1: 60 days 2: 90 days 3: 180 days	0		Main control

11. temperature setting, after connecting the electrical heater to the PCB (LD3 and LD4), then can set the temperature by temperature increase and decrease buttons, when SA temperature lower than setting temperature then electrical heater on

1) 0°C < setting temperature - SA temperature < 5 °C, 1st stage heater on, 2nd stage heater off

2) Setting temperature - SA temperature > 5°C, 1st and 2nd stage heater on

Intelligent Controller Instruction

12. Instruction of Parameter Settings

1) The control panel is in parameter setting mode via pressing the MODE button more than 6 seconds.

2) In the parameter setting mode, the valid parameter number (00/01/02/03/04/05/06/07/08/21/23/23/24/25) is shown in the middle of the screen, press button SET to switch the parameter number. Then press MODE to enter the parameter setting, the default value at the right corner flashes, press the up-down button to adjust the data. After setting, press SET button to save all the data. After 10 seconds, the control panel begins to record the parameters. The setting is proved to be successful if the parameters

13. Bypass opening parameter setting

1) The bypass is opened on the condition that the outdoor temperature is equal or higher than X and less than X+Y.

2) The bypass is closed on other conditions.

14. EA fan defrosting mode

When EA side of heat exchanger temperature lower than -1°C (defrosting entering temperature, adjustable) and last for 1 minute, and the interval of defrosting is longer than 30 minutes (adjustable), the exhaust fan will run at high speed automatically for defrosting, and supply fan will stop, until EA side temperature higher than defrosting entering temperature $+15^{\circ}\text{C}$ for 1 minute, or the defrosting time is longer than 10 minutes (adjustable)

15. Filter Alarm, to set the filter alarm under parameter 25, the symbol  flash as the filter alarm to remind customer to clean the filters, to sweep filter alarm by setting parameter 24 value 1.

16. Error code, press set button for short to check the Error code, please refer to below error code table

Code	Error
E1	Fresh air temperature sensor error
E2	EEPROM error
E3	Return air temperature sensor error
E4	Exhaust air temperature sensor error (defrosting temperature error)
E5	Communication error
E6	Supply air temperature sensor error

Maintenance

Warning

Power must be isolated before installation and maintenance to avoid injury or electric shock. Supply power cables, main circuit breaker and earth leakage protection, must comply with national regulations. Failure to observe could cause unit failure, electric shock or fire.

Standard filtration is supplied with this unit and must be used. Dust and dirt can accumulate in the heat exchanger if filters are removed. (This can lead to failure or decreased performance). To ensure efficient operation, regular cleaning or replacement of filters is required. Filter maintenance frequency will depend on working environment and unit running time.

Cleaning the filter

1. Open the access door
2. Remove the filters (from the side of the unit)
3. Vacuum the filters to get rid of the dust and dirt. For bad conditions dip it into water with soft wash to clean.
4. Push the filters to the positions after they get dried naturally, close the access door.
5. Change the filters if they are badly affected with dust and dirt or if they are broken.

Maintenance of heat exchanger

1. Pull off the filters first
2. Draw out the exchanger from the unit
3. Establish a cleaner schedule to clean the dust and dirt on the exchanger.
4. Install the exchanger and filters to their positions and close the access door.

Remarks: It is recommended maintenance of the exchanger is made every 3 years

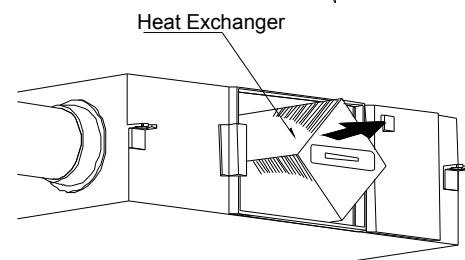
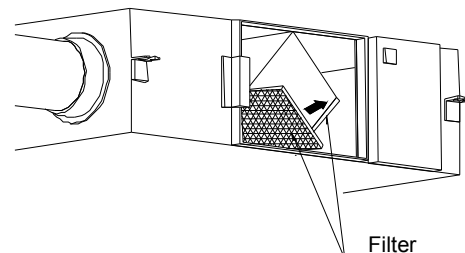
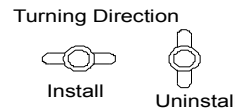
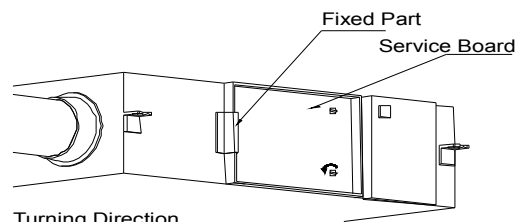

Failure diagnose

User can use the unit after trial operation. Before contacting us, you can make self trouble shooting following below chart in case of any failure.

Phenomenon	Possible reason	Solutions
The airflow volumes both indoor and outdoor vents drop obviously after a period of operation.	Dust and dirt blocking the filter	Replace or clean the filter
Noise comes from vents	Vents installation are losing.	Re-tightening the vents connections
Unit doesn't work	<ol style="list-style-type: none"> 1. No electricity 2. Protection breaker is cut 	<ol style="list-style-type: none"> 1. Guarantee power is on 2. Connect the breaker